

# CMT ORANGE TOOLS®

## CATALOGUE 2024 ENGLISH EDITION

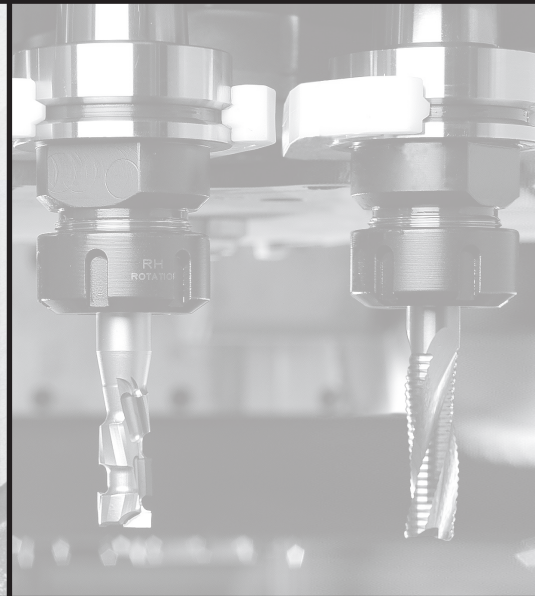

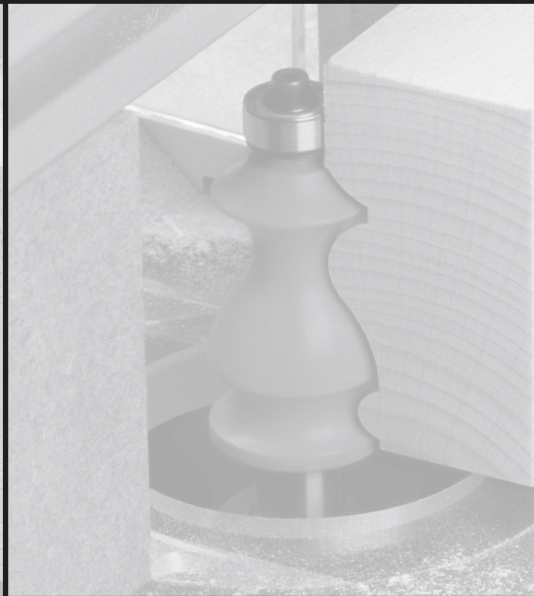
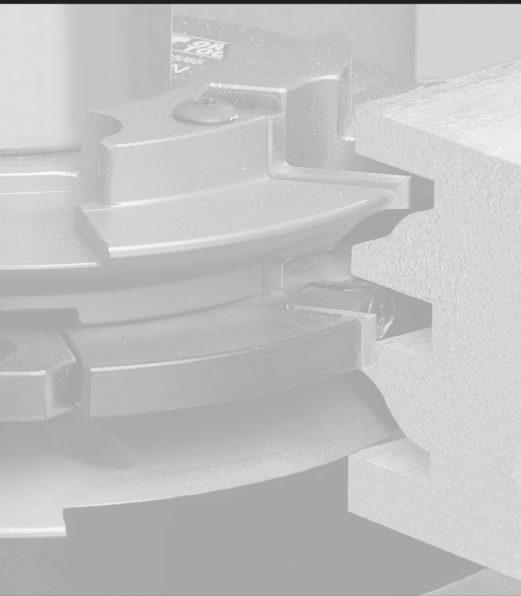

# BITS FOR HAND POWER TOOLS



PRODUCTS	PAGE
Adaptors & Extension	356-357
Interchangeable Boring Bits	357
Boring Bits	358~361
Mortise Chisel & Bit Sets	361
Plug Cutters & Sets	362-363
Forstner Bits	364
Rosette Cutters	365
Bits for MAFELL® & FESTOOL® Machines	366
Auger	367
Brad Point Bits & Sets	367~369
Drill Bits for ANUBA® Hinges	369
Countersinks & Drills	370~373



Adaptors

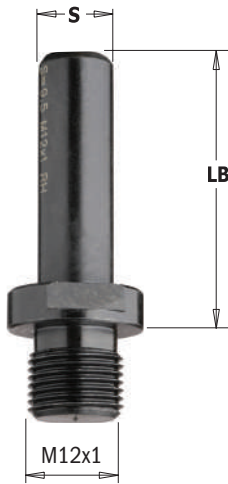

**509-532-533** ...WITH PARALLEL SHANK FOR INTERCHANGEABLE BITS

**RH LH**

S mm	LB mm			ORDER NO. Right-hand rotation	ORDER NO. Left-hand rotation
8x30	35		10	532.080.01	
9,5x30	35		10	532.095.01	
10x50	60		1	533.100.01	
12x30	35		10	532.120.01	
13x50	100		1	509.130.01	509.130.02
16x50	100		1	509.160.01	509.160.02

For use with the following parts: **501 HW**

**TECHNICAL DETAILS:**

- Strength steel.
- Precision grinding on all contact surfaces.

**APPLICATION:**

for use on boring machines equipped with adaptors and/or chucks.

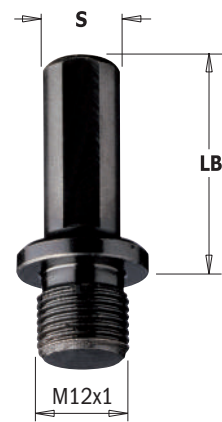

**511** ...WITH PARALLEL SHANK FOR QUICK CHANGE DRILLS

**RH LH**

S mm	LB mm		ORDER NO. Right-hand rotation	ORDER NO. Left-hand rotation
10x20 (with driving flat and screw)	27	10	511.270.01	511.270.02
10x35 (with driving flat and screw)	40	10	511.400.01	511.400.02

For use with the following parts: **501 HW**

**TECHNICAL DETAILS:**

- Strength steel.
- Precision grinding on all contact surfaces.

**APPLICATION:**

for use on boring machines equipped with adaptors and/or chucks.

Spare parts  
  
990.003.00



**506**

**RH LH**

S mm	LB mm		ORDER NO. Right-hand rotation	ORDER NO. Left-hand rotation
M10/11x4	15	1	506.150.01	506.150.02
M10/11x4	25	1	506.250.01	506.250.02
M10/11x4	35	1	506.350.01	506.350.02

For use with the following parts: **501 HW**

**TECHNICAL DETAILS:**

- Strength steel.
- Precision grinding on all contact surfaces.

**APPLICATION:**

for use on boring machines equipped with adaptors and/or chucks.



**503**

**RH LH**

S mm	LB mm		ORDER NO. Right-hand rotation	ORDER NO. Left-hand rotation
M10/30°	25	1	503.250.01	503.250.02
M10/30°	35	1	503.350.01	503.350.02
M10/30°	45	1	503.450.01	503.450.02

For use with the following parts: **501 HW**

**TECHNICAL DETAILS:**

- Strength steel.
- Precision grinding on all contact surfaces.

**APPLICATION:**

for use on boring machines equipped with adaptors and/or chucks.





**534**

S mm				ORDER NO. Right-hand rotation	
MK2/Ø20x14F.x1"			1	<b>534.020.01</b>	
MK2/M30x1,5			1	<b>534.030.01</b>	

For use with the following parts: **501** HW

**TECHNICAL DETAILS:**

- Strength steel.

**APPLICATION:**

for use on CNC machining centers or hand-held routers equipped with adaptors and/or chucks.

Extension for drills with hexagonal shank



**507**

S	mm	L inches	B mm		ORDER NO.
Hexagonal 1/4"	330	13	8	25	<b>507.080.33</b>
Hexagonal 11/32"	330	13	9,5	25	<b>507.095.33</b>
Hexagonal 11/32"	330	13	10	25	<b>507.100.33</b>

**TECHNICAL DETAILS:**

- High strength steel.  
- Precision grinding on all contact surfaces.

Interchangeable Boring Bits with Threaded Shank

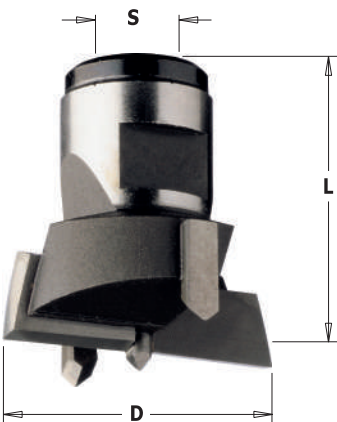

**501**

D mm	L mm	S mm			ORDER NO. Right-hand rotation	ORDER NO. Left-hand rotation
20	30	M12x1		1	<b>501.200.11</b>	<b>501.200.12</b>
22	30	M12x1		1	<b>501.220.11</b>	<b>501.220.12</b>
24	30	M12x1		1	<b>501.240.11</b>	<b>501.240.12</b>
25	30	M12x1		1	<b>501.250.11</b>	<b>501.250.12</b>
26	30	M12x1		1	<b>501.260.11</b>	<b>501.260.12</b>
30	30	M12x1		1	<b>501.300.11</b>	<b>501.300.12</b>
32	30	M12x1		1	<b>501.320.11</b>	<b>501.320.12</b>
34	30	M12x1		1	<b>501.340.11</b>	<b>501.340.12</b>
35	30	M12x1		1	<b>501.350.11</b>	<b>501.350.12</b>
36	30	M12x1		1	<b>501.360.11</b>	<b>501.360.12</b>
38	30	M12x1		1	<b>501.380.11</b>	<b>501.380.12</b>
40	30	M12x1		1	<b>501.400.11</b>	<b>501.400.12</b>
45	30	M12x1		1	<b>501.450.11</b>	<b>501.450.12</b>
50	30	M12x1		1	<b>501.500.11</b>	<b>501.500.12</b>
55	30	M12x1		1	<b>501.550.11</b>	<b>501.550.12</b>
60	30	M12x1		1	<b>501.600.11</b>	<b>501.600.12</b>



# Boring Bits with Parallel Shank

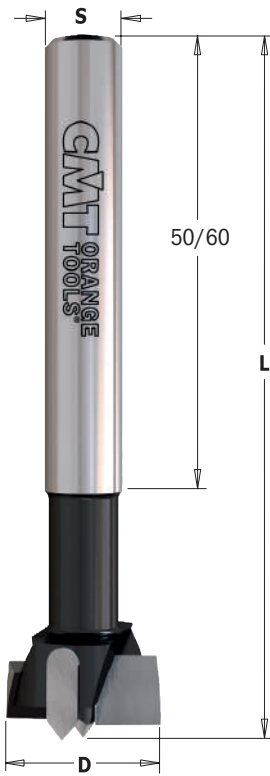

## 512

**HW Z2 V2 RH**

D mm	L mm	S mm		ORDER NO. Right-hand rotation
14	90	10x60	10	512.140.11
15	90	10x60	10	512.150.11
16	90	10x60	10	512.160.11
17	90	10x60	10	512.170.11
18	90	10x60	10	512.180.11
19	90	10x60	10	512.190.11
20	90	10x60	10	512.200.11
21	90	10x60	10	512.210.11
22	90	10x60	10	512.220.11
23	90	10x60	10	512.230.11
24	90	10x60	10	512.240.11
25	90	10x60	10	512.250.11
26	90	10x60	10	512.260.11
27	90	10x60	10	512.270.11
28	90	10x60	10	512.280.11
29	90	10x60	10	512.290.11
30	90	10x60	10	512.300.11
31	90	10x60	10	512.310.11
32	90	10x60	10	512.320.11
33	90	10x60	10	512.330.11
34	90	10x60	10	512.340.11
35	90	10x60	10	512.350.11
38	90	10x60	10	512.380.11
40	90	10x60	10	512.400.11
42	90	10x60	10	512.420.11
45	90	10x50	10	512.450.11
48	90	10x50	10	512.480.11
50	90	10x50	10	512.500.11
55	90	10x50	5	512.550.11
58	90	10x50	5	512.580.11
60	90	10x50	5	512.600.11

**TECHNICAL DETAILS:**

- Strength steel.
- HW balanced centre point.
- 2 HW ground cutting edges [Z2].
- 2 HW negatively ground spurs [V2].
- **Parallel shank.**

**APPLICATION:**

for drilling blind holes in solid wood, wood derivatives and laminate materials.

**Ideal for hinges.**

## 5 Piece Boring Bit Set for Hinges



## 512.001.01

**HW Z2 V2 RH**

The perfect set for hinge work and other related applications. Machined from special high speed steel and featuring tungsten carbide tipped cutting edges.

**TECHNICAL DETAILS:**

- Strength steel.
- HW balanced centre point.
- 2 HW ground cutting edges [Z2].
- 2 HW negatively ground spurs [V2].
- **Parallel shank.**

**APPLICATION:**

for drilling blind holes in solid wood, wood derivatives and laminated materials.

**Ideal for hinges.**

DESCRIPTION	S mm	L mm	BIT DIAMETER mm		ORDER NO. Right-hand rotation
5 Piece Boring Bit Set for Hinges	10	90	15-20-25-30-35	5	512.001.01

# Boring Bits with Parallel Shank

SP Z2 V2 RH

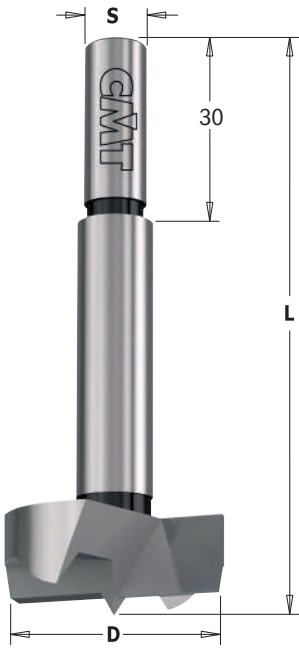

## 512

D mm	L mm	S mm		ORDER NO. Right-hand rotation
8	90	8x30	10	512.081.31
10	90	8x30	10	512.101.31
12	90	8x30	10	512.121.31
14	90	8x30	10	512.141.31
15	90	8x30	10	512.151.31
16	90	8x30	10	512.161.31
18	90	8x30	10	512.181.31
20	90	8x30	10	512.201.31
22	90	8x30	10	512.221.31
24	90	8x30	10	512.241.31
25	90	8x30	10	512.251.31
26	90	8x30	10	512.261.31
28	90	8x30	10	512.281.31
30	90	8x30	10	512.301.31
32	90	10x30	10	512.321.31
34	90	10x30	10	512.341.31
35	90	10x30	10	512.351.31
38	90	10x30	10	512.381.31
40	90	10x30	10	512.401.31
45	90	10x30	10	512.451.31
50	90	10x30	10	512.501.31

### TECHNICAL DETAILS:

- Dependable DIYer tools. Great quality/price ratio.
- SP steel.
- SP balanced centre point.
- 2 SP ground cutting edges [Z2].
- 2 SP ground spurs [V2].
- Parallel shank.

### APPLICATION:

used for drilling blind holes in solid wood, wood derivatives and laminates.  
**Ideal for hinges.**

# 5 Piece Boring Bit Set for Hinges



## 512.001.00

SP Z2 V2 RH

The perfect hinge work set for the most popular brand applications. Machined from special high speed steel its really does a great job for those traditional hinge jobs.

### TECHNICAL DETAILS:

- Dependable DIYer tools. Great quality/price ratio.
- SP steel.
- SP balanced centre point.
- 2 SP ground cutting edges [Z2].
- 2 SP ground spurs [V2].
- Parallel shank.

### APPLICATION:

for drilling blind holes in solid wood, wood derivatives and laminates.  
**Ideal for hinges.**

DESCRIPTION	S mm	L mm	BIT DIAMETER mm		ORDER NO. Right-hand rotation
5 Piece Boring Bit Set for Hinges	10	90	15-20-25-30-35	5	512.001.00

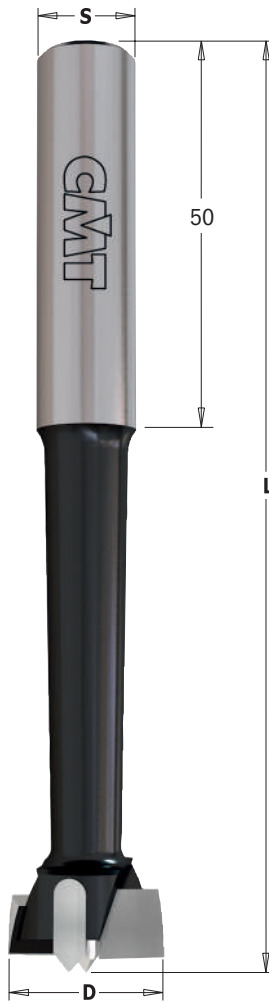

# Boring Bits with Parallel Shank

**HW Z2 V2 RH**

## 513

D mm	L mm	S mm		ORDER NO. Right-hand rotation
15	120	13	1	513.150.11
16	120	13	1	513.160.11
18	120	13	1	513.180.11
20	120	13	1	513.200.11
22	125	13	1	513.220.11
25	125	13	1	513.250.11
26	125	13	1	513.260.11
28	130	13	1	513.280.11
30	130	13	1	513.300.11
35	130	13	1	513.350.11
40	130	13	1	513.400.11
45	130	13	1	513.450.11
50	130	13	1	513.500.11
55	140	13	1	513.550.11
60	140	13	1	513.600.11

## 514

D mm	L mm	S mm		ORDER NO. Right-hand rotation
15	120	16	1	514.150.11
16	120	16	1	514.160.11
18	120	16	1	514.180.11
20	120	16	1	514.200.11
22	125	16	1	514.220.11
25	125	16	1	514.250.11
26	125	16	1	514.260.11
28	130	16	1	514.280.11
30	130	16	1	514.300.11
32	130	16	1	514.320.11
35	130	16	1	514.350.11
40	130	16	1	514.400.11
45	130	16	1	514.450.11
50	130	16	1	514.500.11
55	140	16	1	514.550.11
60	140	16	1	514.600.11

### TECHNICAL DETAILS:

- Strength steel.
- HW balanced centre point.
- 2 HW ground cutting edges [Z2].
- 2 HW negatively ground spurs [V2].
- **Parallel shank.**

### APPLICATION:

for drilling blind holes in solid wood, wood derivatives and laminates.

**Ideal for hinges.**

## Boring Bits with Parallel Shank

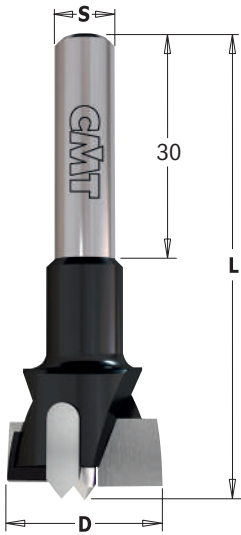

**392**

**HW Z2 V2 RH**

D mm	L mm	S mm		ORDER NO. Right-hand rotation
15	60	8	10	392.150.11
20	60	8	10	392.200.11
25	60	8	10	392.250.11
26	60	8	10	392.260.11
30	60	8	10	392.300.11
35	60	8	10	392.350.11
35	60	12,7	10	392.351.11
40	60	8	10	392.400.11

**TECHNICAL DETAILS:**

- Strength steel.
- HW balanced centre point.
- 2 HW ground cutting edges [Z2].
- 2 HW negatively ground spurs [V2].
- **Parallel shank.**

**APPLICATION:**

for drilling blind holes in solid wood, wood derivatives and laminates.  
**Ideal for hinges.**

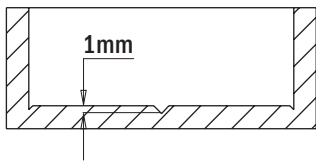

New construction with 1mm centre point

## Mortise Chisel & Bit Sets



**543**

**HSS Z1 RH**

D		S			ORDER NO. Right-hand rotation
mm	inches	mm	inches		
6,35	1/4	19	3/4	1	543.064.51
8	5/16	19	3/4	1	543.079.51
9,5	3/8	19	3/4	1	543.095.51
12,7	1/2	19	3/4	1	543.127.51
15,8	5/8	19	3/4	1	543.158.51
19	3/4	19	3/4	1	543.190.51

It's tough to beat the old faithful mortise and tenon joint for strength and accuracy, even with all the other joinery options in the world of woodworking. It isn't the easiest joint to make, but it surely helps to have the best quality tools in your shop. That's why we've added a new selection of chisel and bit sets in all the popular sizes 6,35mm (1/4") to 19mm (3/4") diameter.

These sets are for use on any standard drill press mortising attachment of mortising machines.



Sample of Chisel Mortiser



**SP RH**

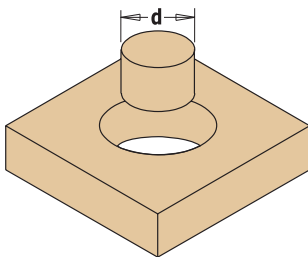

## 529

d mm	D mm	L mm	S mm	Z		ORDER NO. Right-hand rotation
8	18	140	13	4	5	529.080.31
10	20	140	13	4	5	529.100.31
12	24	140	13	4	5	529.120.31
14	26	140	13	4	5	529.140.31
15	27	140	13	4	5	529.150.31
16	28	140	13	4	5	529.160.31
18	30	140	13	4	5	529.180.31
20	32	140	13	4	5	529.200.31
22	34	140	13	5	5	529.220.31
25	37	140	13	5	5	529.250.31
30	42	140	13	5	5	529.300.31
32	44	140	13	5	5	529.320.31
35	47	160	16	6	2	529.350.31
40	52	160	16	6	2	529.400.31
45	57	160	16	6	2	529.450.31
50	62	160	16	6	2	529.500.31

d inches	D inches	L inches	S inches	Z		ORDER NO. Right-hand rotation
3/8	49/64	5-1/2	1/2	4	5	529.095.31
1/2	61/64	5-1/2	1/2	4	5	529.127.31
5/8	1-7/64	5-1/2	1/2	4	5	529.158.31
3/4	1-7/32	5-1/2	1/2	4	5	529.191.31
7/8	1-11/32	5-1/2	1/2	4	5	529.222.31
1	1-15/32	5-1/2	1/2	5	5	529.254.31
1-1/4	1-19/32	5-1/2	1/2	5	5	529.317.31
1-3/8	1-27/32	6-5/16	5/8	6	2	529.349.31
1-1/2	1-31/32	6-5/16	5/8	6	2	529.381.31
1-5/8	2-3/32	6-5/16	5/8	6	2	529.413.31
1-3/4	2-7/32	6-5/16	5/8	6	2	529.445.31
2	2-15/32	6-5/16	5/8	6	2	529.508.31

Use our D=16mm bushing to increase the 13mm shank (article no. **799.130.00** on page 440)

**TECHNICAL DETAILS:**

- Dependable DIYer tools. Great quality/price ratio.
- SP steel.
- 4 cutting edges.

**APPLICATION:**

for drilling plugs in natural soft or medium-density woods.

D mm	D inches	Max RPM Softwood	Max RPM Hardwood
< Ø16	5/8	1000	500
< Ø40	1-37/64	500	300
> Ø40	1-37/64	200	150

## 500.001/02/03

**SP RH**

We offer a wide range of boring bits and plug cutters in the most popular diameters. If you need to drill plugs in soft to medium-density hardwood, you've got three different sets to choose from. **Dependable DIYer tools. Great quality/price ratio.**

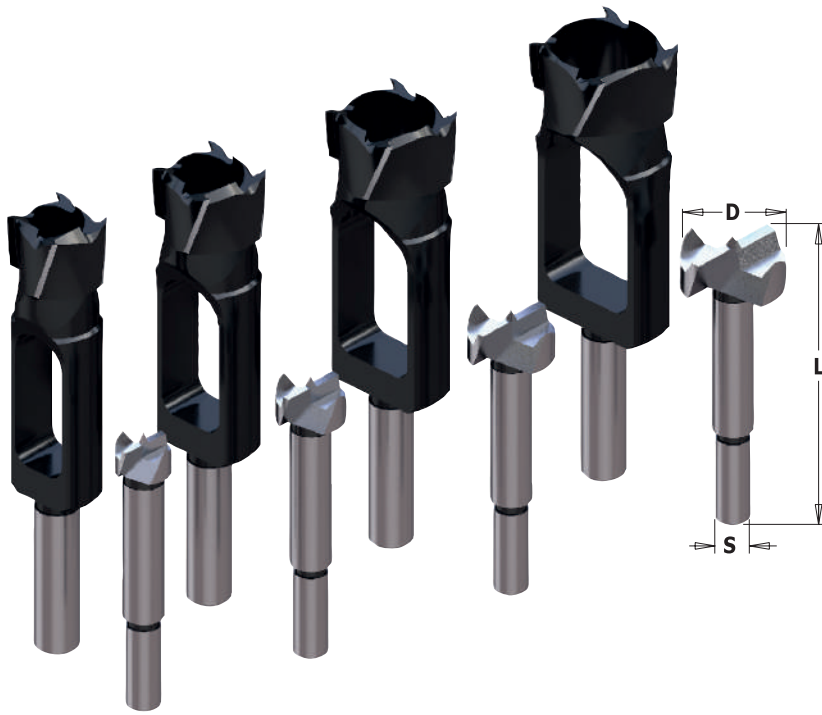

### 500.001.08 BORING BIT & PLUG CUTTER SET

SET CONTAINS	D mm	L mm	S mm	ORDER NO. Right-hand rotation
Boring Bit with Parallel Shank	8	90	10	<b>512.081.31</b>
Boring Bit with Parallel Shank	10	90	10	<b>512.101.31</b>
Boring Bit with Parallel Shank	12	90	10	<b>512.121.31</b>
Boring Bit with Parallel Shank	15	90	10	<b>512.151.31</b>
Plug Cutter	8	140	13	<b>529.080.31</b>
Plug Cutter	10	140	13	<b>529.100.31</b>
Plug Cutter	12	140	13	<b>529.120.31</b>
Plug Cutter	15	140	13	<b>529.150.31</b>



### 500.002.08 BORING BIT & PLUG CUTTER SET

SET CONTAINS	D mm	L mm	S mm	ORDER NO. Right-hand rotation
Boring Bit with Parallel Shank	16	90	10	<b>512.161.31</b>
Boring Bit with Parallel Shank	20	90	10	<b>512.201.31</b>
Boring Bit with Parallel Shank	25	90	10	<b>512.251.31</b>
Boring Bit with Parallel Shank	30	90	10	<b>512.301.31</b>
Plug Cutter	16	140	13	<b>529.160.31</b>
Plug Cutter	20	140	13	<b>529.200.31</b>
Plug Cutter	25	140	13	<b>529.250.31</b>
Plug Cutter	30	140	13	<b>529.300.31</b>

### 500.003.08 BORING BIT & PLUG CUTTER SET

SET CONTAINS	D mm	L mm	S mm	ORDER NO. Right-hand rotation
Boring Bit with Parallel Shank	15	90	10	<b>512.151.31</b>
Boring Bit with Parallel Shank	20	90	10	<b>512.201.31</b>
Boring Bit with Parallel Shank	25	90	10	<b>512.251.31</b>
Boring Bit with Parallel Shank	30	90	10	<b>512.301.31</b>
Plug Cutter	15	140	13	<b>529.150.31</b>
Plug Cutter	20	140	13	<b>529.200.31</b>
Plug Cutter	25	140	13	<b>529.250.31</b>
Plug Cutter	30	140	13	<b>529.300.31</b>



Forstner Bits

SP Z2 V2 RH



**537**

D mm	L mm	S mm		ORDER NO. Right-hand rotation
10	90	8	6	537.100.31
12	90	8	6	537.120.31
14	90	8	6	537.140.31
15	90	8	6	537.150.31
16	90	8	6	537.160.31
18	90	8	6	537.180.31
20	90	8	6	537.200.31
22	90	8	6	537.220.31
24	90	8	6	537.240.31
25	90	8	6	537.250.31
26	90	8	6	537.260.31
28	90	8	6	537.280.31
30	90	8	6	537.300.31
32	90	10	6	537.320.31
35	90	10	6	537.350.31
38	90	10	6	537.380.31
40	90	10	6	537.400.31
45	90	10	6	537.450.31
50	90	10	6	537.500.31
55	90	10	6	537.550.31
68	157	12,7	6	537.680.31
70	157	12,7	6	537.700.31
75	157	12,7	2	537.750.31
80	157	12,7	2	537.800.31
85	157	12,7	2	537.850.31
90	157	12,7	2	537.900.31
95	157	12,7	2	537.950.31
100	157	12,7	2	537.990.31

Toothed rim >=Ø25mm



Standard rim <Ø25mm

D inches	L inches	S inches		ORDER NO. Right-hand rotation
1/4	3-35/64	3/8	6	537.064.31
3/8	3-35/64	3/8	6	537.095.31
1/2	3-35/64	3/8	6	537.127.31
5/8	3-35/64	3/8	6	537.158.31
3/4	3-35/64	3/8	6	537.190.31
7/8	3-35/64	3/8	6	537.222.31
1	3-35/64	3/8	6	537.254.31
1-1/8	3-35/64	3/8	6	537.285.31
1-1/4	3-35/64	3/8	6	537.317.31
1-3/8	3-35/64	3/8	6	537.349.31
1-1/2	3-35/64	3/8	6	537.381.31
1-5/8	3-35/64	3/8	6	537.413.31
1-3/4	3-35/64	3/8	6	537.445.31
1-7/8	3-35/64	3/8	6	537.476.31
2	3-35/64	3/8	6	537.508.31
2-1/8	3-35/64	3/8	6	537.540.31
2-1/4	6-3/16	3/8	6	537.571.31
2-1/2	6-3/16	3/8	6	537.635.31
3	6-3/16	3/8	2	537.762.31
3-1/2	6-3/16	3/8	2	537.889.31
4	6-3/16	3/8	2	537.991.31
4-1/2	4-17/32	3/8	2	537.993.31

**TECHNICAL DETAILS:**

- Dependable DIYer tools. Great quality/price ratio.
- SP steel.
- SP balanced centre point.
- 2 SP precision ground cutting edges [Z2].
- 2 SP ground spurs [V2].
- Parallel shank.

**APPLICATION:**

for drilling flat bottom holes of any size in softwood. Create oval and arched openings at any angle. Create niches for the installation of brackets/straps, frames/grids.

**STANDARD RIM AND TOOTHED RIM:**

Standard rims provide better guidance but tend to over-heat. To overcome heat the larger diameters (>=Ø25mm) are designed with toothed rims.

Forstner Bit Sets

We offer a wide range of Forstner bits in the most popular diameters to execute holes for brackets/straps in softwood. Drill ovals and arched openings at any angle for the installation of hinge parts. Available in 4, 5, 7, 12 and 16 bit sets.

Dependable DIYer tools. Great quality/price ratio.

**537.000.16**

SP Z2 V2 RH

- 537.000.04
- 537.000.05
- 537.000.07
- 537.000.12



DESCRIPTION	SHANK mm	SHANK inches	BIT DIAMETER		ORDER NO. Right-hand rotation
5 pcs. Forstner Bit Set in clamshell	Ø8-10		Ø15-20-25-30-35mm	6	537.000.05
12 pcs. Forstner Bit Set in clamshell	Ø8-10		Ø10-12-14-15-16-18-20-22-25-26-30-35mm	6	537.000.12
4 pcs. Forstner Bit Set in clamshell		Ø3/8	Ø1/4" - 1/2" - 3/4" - 1"	6	537.000.04
7 pcs. Forstner Bit Set in clamshell		Ø3/8	Ø1/4" - 3/8" - 1/2" - 5/8" - 3/4" - 7/8" - 1"	6	537.000.07
16 pcs. Forstner Bit Set in plastic box		Ø3/8	Ø1/4" - 3/8" - 1/2" - 5/8" - 3/4" - 7/8" - 1" - 1-1/8" - 1-1/4" - 1-3/8" - 1-1/2" - 1-5/8" - 1-3/4" - 1-7/8" - 2" - 2-1/8"	8	537.000.16



## 531

**HW** **Z2** **RH**

D mm	L mm	S mm	MAX RPM		ORDER NO. Right-hand rotation
54	73,5	9,5	1500	10	<b>531.541</b>
54	71,3	9,5	1500	10	<b>531.542</b>
54	67,3	9,5	1500	10	<b>531.543</b>
54	72,3	9,5	1500	10	<b>531.544</b>
70	76,5	9,5	1000	5	<b>531.701</b>
70	74	9,5	1000	5	<b>531.702</b>

**TECHNICAL DETAILS:**

- Strength steel.
- 2 HW precision ground cutting edges [Z2].
- Parallel hexagonal shank.

**APPLICATION:**

for use on drill presses and low speed power tools (see table above for max RPM). We recommend securely clamping your workpiece throughout drilling operations.

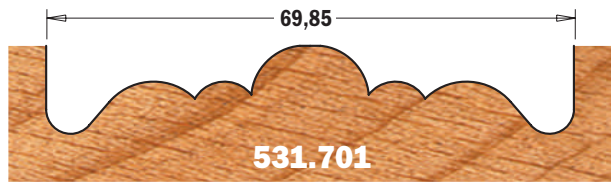
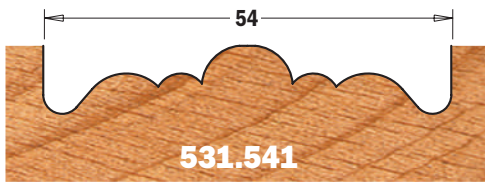

Drawing is 1:1 scale



**531.541**  
**531.701**

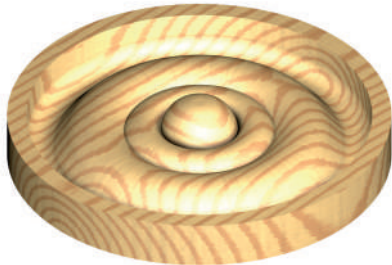

**531.543**

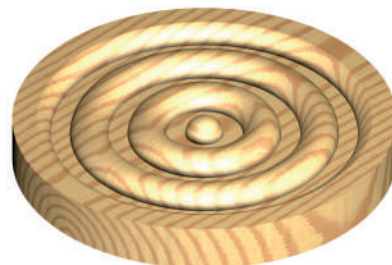

**531.542**  
**531.702**

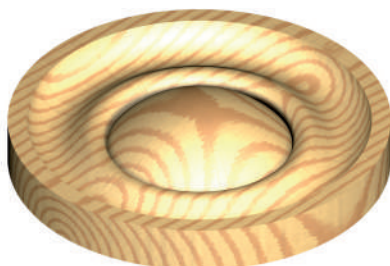

**531.544**

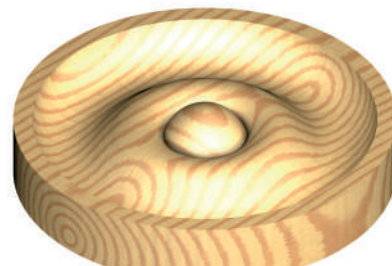



## 312

HW Z2 RH

D mm	I mm	L mm	S mm		ORDER NO. Right-hand rotation
4	30	58	8	10	312.040.11
5	30	58	8	10	312.050.11
6	30	58	8	10	312.060.11
8	30	58	8	10	312.080.11
10	30	58	8	10	312.100.11
12	30	58	8	10	312.120.11
14	30	58	8	10	312.140.11
16	30	58	8	10	312.160.11

### TECHNICAL DETAILS:

- Premium quality strength steel body.
- High quality HW tip.
- 2 cutting edges [Z2].
- No lateral spurs.
- 2 spiral flutes.
- Balanced centre point.
- Black P.T.F.E. coating.
- **Parallel shank with driving flat and length adjusting screw.**

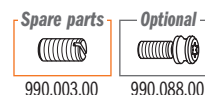

### APPLICATION:

for drilling blind holes in solid wood, wood derivatives and laminates.  
For use on hand-held routers and MAFELL® machines - model DD40.

# Router Bits for DOMINO® Joining Machines by FESTOOL®



## 380

HW HWM Z2 RH

D mm	I mm	L mm	S mm	FESTOOL®		ORDER NO. Right-hand rotation
• 4	11	38	M6x0,75	DF500	10	380.040.11
5	20	49	M6x0,75	DF500	10	380.050.11
6	28	49	M6x0,75	DF500	10	380.060.11
8	28	49	M6x0,75	DF500	10	380.080.11
10	28	49	M6x0,75	DF500	10	380.100.11
8	50	90	M8x1	DF700	10	380.081.11
10	70	90	M8x1	DF700	10	380.101.11
12	70	90	M8x1	DF700	10	380.121.11
14	70	90	M8x1	DF700	10	380.141.11

### • HWM

### TECHNICAL DETAILS:

- Premium quality strength steel body.
- High quality HW tip.
- 2 cutting edges [Z2].
- No lateral spurs.
- 2 spiral flutes.
- Black P.T.F.E. coating.
- Threaded shank.

### APPLICATION:

for use on "DOMINO®" machines to rout slots for hinges.

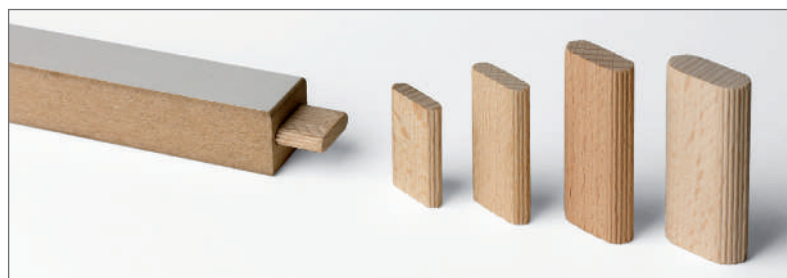



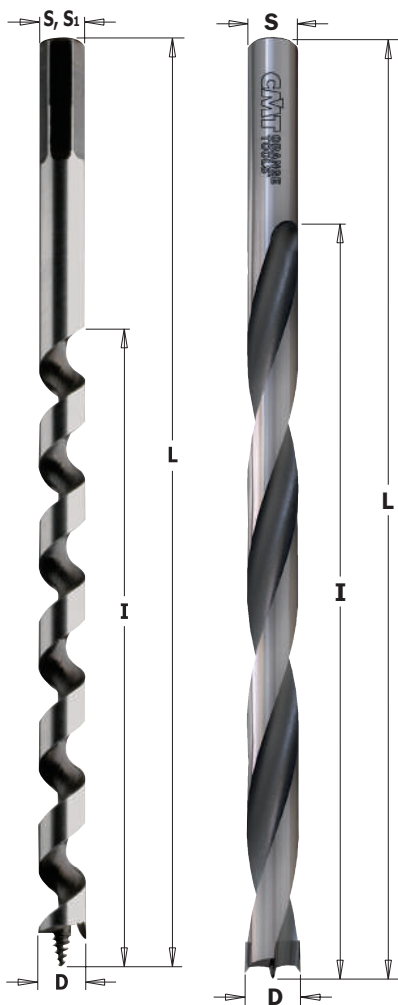

## 542-535

**HSS** **Z1** **V1** **RH**

D mm	I mm	L mm	S	S <sub>1</sub> mm	RPM max		ORDER NO. Right-hand rotation
6	155	230	Hexagonal	6	800 ~ 1400	1	542.060.51
8	155	230	Hexagonal	6,35	800 ~ 1400	1	542.080.51
10	155	230	Hexagonal	9	600 ~ 1200	1	542.100.51
12	155	230	Hexagonal	12	600 ~ 1100	1	542.120.51
14	155	230	Hexagonal	12	600 ~ 1000	1	542.140.51
16	155	230	Hexagonal	12	500 ~ 900	1	542.160.51
18	155	230	Hexagonal	12	500 ~ 800	1	542.180.51
20	155	230	Hexagonal	12	400 ~ 700	1	542.200.51
8	360	460	Hexagonal	6,55	800 ~ 1000	1	535.080.51
10	360	460	Hexagonal	9	600 ~ 1000	1	535.100.51
12	360	460	Hexagonal	12	600 ~ 1000	1	535.120.51
14	360	460	Hexagonal	12	500 ~ 900	1	535.140.51
16	360	460	Hexagonal	12	500 ~ 900	1	535.160.51
18	360	460	Hexagonal	12	450 ~ 800	1	535.180.51
20	360	460	Hexagonal	12	400 ~ 700	1	535.200.51

### TECHNICAL DETAILS:

- HSS steel.
- Balanced centre point.
- 1 HSS cutting edge [Z1] + 1 spur [V1].
- 1 spiral flute.

### APPLICATION:

for deep boring on soft and medium-density wood. Ideal for the preparation and installation of floating shelves.

## 542

**HW** **Z2** **V2** **RH**

D mm	I mm	L mm	S mm		ORDER NO. Right-hand rotation
12	180	240	13	1	542.120.11
14	180	240	13	1	542.140.11

### TECHNICAL DETAILS:

- Strength steel.
- High quality HW tip.
- Balanced centre point.
- 2 HW cutting edge [Z2] + 2 spurs [V2].
- 2 spiral flute.

### APPLICATION:

for deep boring on soft and medium-density wood. Ideal for the preparation and installation of floating shelves.

# Brad Point Bits & Stop Collars

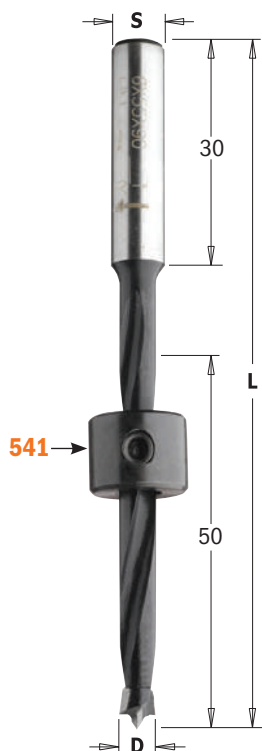

## 540

**HW** **Z2** **V2** **RH**

D mm	L mm	S mm		ORDER NO. Right-hand rotation
5	90	8x30	1	540.050.11
6	90	8x30	1	540.060.11
8	90	8x30	1	540.080.11
10	90	8x30	1	540.100.11
12	90	8x30	1	540.120.11

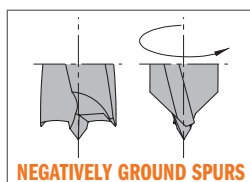

### TECHNICAL DETAILS:

- Strength steel.
- High quality HW tip.
- Balanced centre point.
- 2 HW cutting edge [Z2] + 2 spurs [V2].
- 2 spiral flute.

### APPLICATION:

for drilling blind holes in solid wood, wood derivatives and laminates. For use on hand-held power drills and drill presses.

## 541 Stop Collars

D mm		ORDER NO.
5	10	541.050.00
6	10	541.060.00
8	10	541.080.00
10	10	541.100.00
12	10	541.120.00

### Spare parts

990.002.00	991.062.00
990.002.00	991.062.00
990.002.00	991.062.00
990.002.00	991.062.00
990.002.00	991.062.00

Stop collars with precision clamping nut and key for quick and easy assembly.

## Brad Point Bits

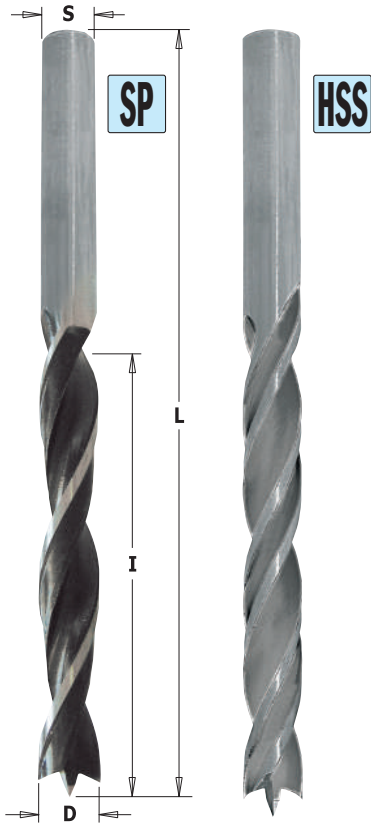

**517**

**SP HSS Z2 RH**

D mm	I mm	L mm	S mm		ORDER NO. Right-hand rotation	<b>SP</b>	ORDER NO. Right-hand rotation	<b>HSS</b>
3	33	61	3,0	1	<b>517.030.31</b>		<b>517.030.51</b>	
4	43	75	4	1	<b>517.040.31</b>		<b>517.040.51</b>	
4,5	47	80	4,5	1			<b>517.045.51</b>	
5	52	86	5	1	<b>517.050.31</b>		<b>517.050.51</b>	
6	57	93	6	1	<b>517.060.31</b>		<b>517.060.51</b>	
7	69	109	7	1	<b>517.070.31</b>		<b>517.070.51</b>	
8	75	117	8	1	<b>517.080.31</b>		<b>517.080.51</b>	
9	80	120	9	1	<b>517.090.31</b>		<b>517.090.51</b>	
10	80	120	10	1	<b>517.100.31</b>		<b>517.100.51</b>	
11	89	142	8	1	<b>517.110.31</b>		<b>517.110.51</b>	
12	96	151	8	1	<b>517.120.31</b>		<b>517.120.51</b>	
13	96	151	8	1	<b>517.130.31</b>		<b>517.130.51</b>	
14	96	151	10	1	<b>517.140.31</b>		<b>517.140.51</b>	
15	100	160	10	1	<b>517.150.31</b>		<b>517.150.51</b>	
16	100	160	10	1	<b>517.160.31</b>		<b>517.160.51</b>	
18	130	180	10	1	<b>517.180.31</b>			
20	135	200	10	1	<b>517.200.31</b>			

**SP**

**TECHNICAL DETAILS:**

- Dependable DIYer tools. Great quality/price ratio.
- SP steel.
- Balanced center point.
- 2 SP cutting edges [Z2].
- 2 flutes.

**APPLICATION:**

for drilling holes in natural wood.

**HSS**

**TECHNICAL DETAILS:**

- Dependable DIYer tools. Great quality/price ratio.
- HSS steel.
- Balanced center point.
- 2 HSS cutting edges [Z2].
- 4 spiral flutes.

**APPLICATION:**

used for drilling holes in soft and hardwood.

## Brad Point Bit Sets



**517**

**HSS SP Z2 RH**

● **5 Piece Brad Point Bit Set**

Safely packaged in a reusable plastic case for easy storage and access. Dependable DIYer tools. Great quality/price ratio.

● **8 Piece Brad Point Bit Set**

Safely packaged in a reusable plastic case for easy storage and access. Dependable DIYer tools. Great quality/price ratio.

DESCRIPTION	Z	BIT DIAMETER		ORDER NO. Right-hand rotation
5 pcs. <b>HSS</b> Brad Point Set	4 flutes	Ø4-5-6-8-10mm	50	<b>517.001.01</b>
5 pcs. <b>SP</b> Brad Point Set	2 flutes	Ø4-5-6-8-10mm	50	<b>517.001.00</b>
8 pcs. <b>HSS</b> Brad Point Set	4 flutes	Ø3-4-5-6-7-8-9-10mm	30	<b>517.002.01</b>
8 pcs. <b>SP</b> Brad Point Set	2 flutes	Ø3-4-5-6-7-8-9-10mm	30	<b>517.002.00</b>

# Brad Point Bits

**HSS Z2 RH LH**

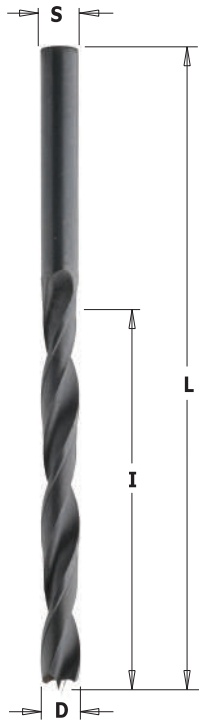

## 516

D mm	I mm	L mm	S mm		ORDER NO. Right-hand rotation	ORDER NO. Left-hand rotation
2	24	49	2	10	516.020.51	516.020.52
2,5	30	57	2,5	10	516.025.51	516.025.52
3	33	61	3	10	516.030.51	516.030.52
3,5	39	70	3,5	10	516.035.51	516.035.52
4	43	75	4	10	516.040.51	516.040.52
4,5	47	80	4,5	10	516.045.51	516.045.52
5	52	86	5	10	516.050.51	516.050.52
5,5	57	93	5,5	10	516.055.51	516.055.52
6	57	93	6	10	516.060.51	516.060.52
7	69	109	7	10	516.070.51	516.070.52
8	75	117	8	10	516.080.51	516.080.52
9	81	125	9	10	516.090.51	516.090.52
10	87	133	10	10	516.100.51	516.100.52

**TECHNICAL DETAILS:**  
 - HSS steel.  
 - Balanced centre point.  
 - 2 HSS cutting edges [Z2].  
 - 2 spiral flutes.

**APPLICATION:**  
 for drilling blind holes in soft and medium-density wood.

# Drill Bits for ANUBA® Hinges

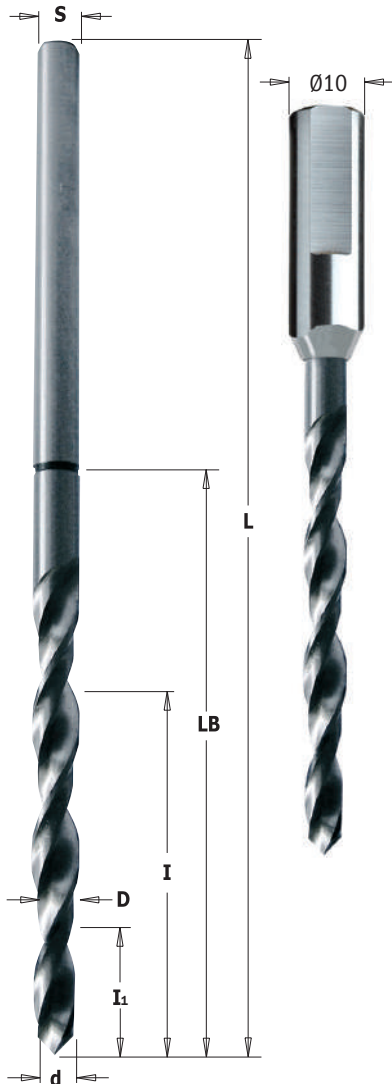

## 515 PARALLEL SHANK

**HSS Z2 RH**

ANUBA® nr.	d mm	D-S mm	I <sub>1</sub> mm	I mm	LB mm	L mm		ORDER NO. Right-hand rotation
9,5	3,8	5,2	18	56	74	132	1	515.095.51
11	4,8	5,7	17	60	76	145	1	515.110.51
13	5,8	6,7	18	68	83	155	1	515.130.51
14,5	6,3	7,2	19	75	89	165	1	515.145.51
16	6,7	7,7	25	85	100	165	1	515.160.51
18	7,7	8,7	25	85	102	165	1	515.180.51
20	8,8	9,8	25	90	104	165	1	515.200.51

## 515 PARALLEL SHANK WITH DRIVING FLAT

ANUBA® nr.	d mm	D mm	I mm	LB mm	S mm	L mm		ORDER NO. Right-hand rotation
13	5,2	6,5	15	50	10x35	85	1	515.131.51
14	5,5	7	15	55	10x35	90	1	515.141.51
16	6	7,7	15	60	10x35	95	1	515.161.51

**TECHNICAL DETAILS:**  
 - HSS steel.  
 - Balanced centre point.  
 - 2 HSS cutting edges [Z2].  
 - 2 spiral flutes.

**APPLICATION:**  
 for drilling holes in medium density wood.  
 For the installation of ANUBA® hinges.





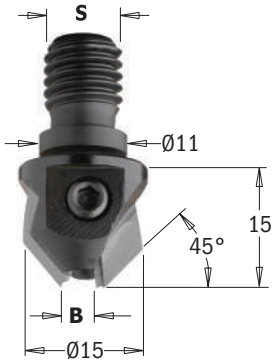

## 350



B mm	S mm			10	ORDER NO. Right-hand rotation	ORDER NO. Left-hand rotation
3	M10/Ø11x4			10	350.030.11	350.030.12
4	M10/Ø11x4			10	350.040.11	350.040.12
5	M10/Ø11x4			10	350.050.11	350.050.12

### TECHNICAL DETAILS:

- Strength steel.
- Countersink: 2 carbide tipped cutting edges [Z2] at 45°.
- Fastening screw for quick and easy drill bit change.
- Threaded shank.

Spare parts



990.001.00

### APPLICATION:

for use with spiral bits featuring a parallel shank of equal dimension to countersink shank diameter.

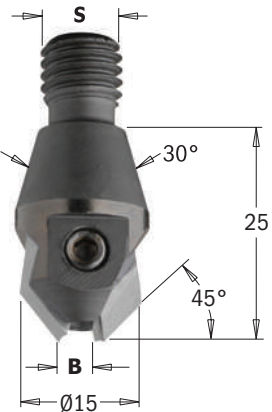

## 351

B mm	S mm			10	ORDER NO. Right-hand rotation	ORDER NO. Left-hand rotation
3	M10/30°			10	351.030.11	351.030.12
4	M10/30°			10	351.040.11	351.040.12
5	M10/30°			10	351.050.11	351.050.12

### TECHNICAL DETAILS:

- Strength steel.
- Countersink: 2 carbide tipped cutting edges [Z2] at 45°.
- Fastening screw for quick and easy drill bit change.
- Threaded shank.

Spare parts



990.001.00

### APPLICATION:

for use with spiral bits featuring a parallel shank of equal dimension to countersink shank diameter.

# Adjustable Countersink

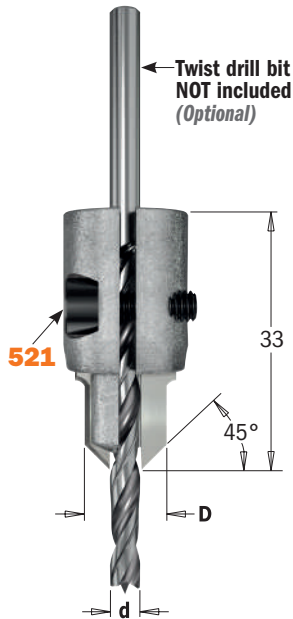

## 521.001



d mm	D mm			10	ORDER NO. Right-hand rotation	Spare parts
3 ~ 7	10 ~ 14			10	521.001.11	990.061.00  991.067.00

For use with the following items: **516-517**

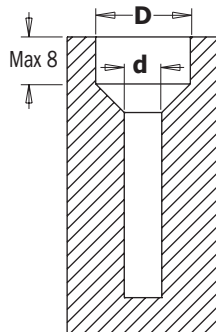

d	D
Ø3	Ø10
Ø4	Ø11
Ø5	Ø12
Ø6	Ø13
Ø7	Ø14

### TECHNICAL DETAILS:

- Strength steel.
- Countersink: 2 carbide tipped cutting edges [Z2] at 45°.
- Fastening screw for quick and easy drill bit change.
- 3mm hex key included.
- Dependable DIYer tools. Great quality/price ratio.

### APPLICATION:

for use with spiral bits featuring a parallel shank of equal dimension to countersink shank diameter.

## Drill Bits with 45° Countersink Set

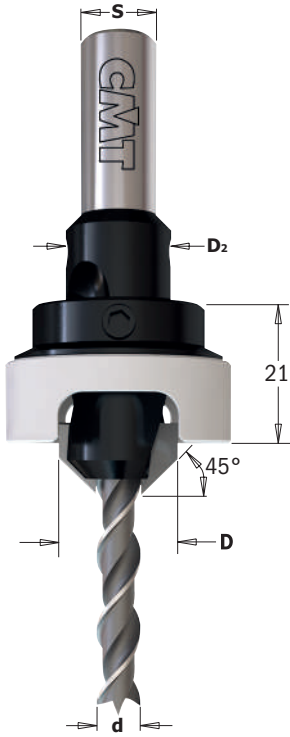

### 521A

d mm	D mm	D <sub>2</sub> mm	A	S mm		ORDER NO. Right-hand rotation
3	12	10	45°	8	10	521.312.11A
4	12	10	45°	8	10	521.412.11A
4,5	16	14	45°	10	10	521.4516.11A
5	16	14	45°	10	10	521.516.11A
6	16	14	45°	10	10	521.616.11A

Spare parts: 990.014.00 Screw  
991.060.00 Hex key

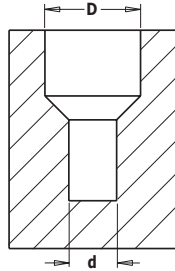

#### TECHNICAL DETAILS:

- Strength steel.
- Countersink: 2 carbide tipped cutting edges [Z2] at 45°.
- Fastening screw for quick and easy drill bit change.
- HSS drill bit.
- Stop collars with precision clamping nut for quick and easy assembly.
- The DELRIN® protection sleeve lets you work without marring the workpiece.

#### APPLICATION:

for drilling countersink and blind holes in solid wood, wood derivatives and laminates. For use with hand-held power drills or drill presses.

Spare parts

521.312.11	517.030.51P	541.101.00
521.412.11	517.040.51P	541.101.00
521.4516.11	517.045.51P	541.141.00
521.516.11	517.050.51P	541.141.00
521.616.11	517.060.51P	541.141.00



## Drill Bits with 90° Countersink Set

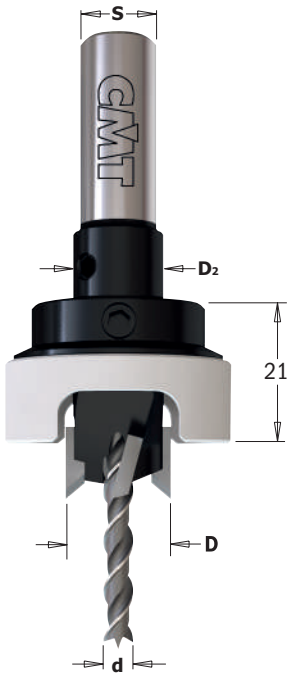

### 515A

d mm	D mm	D <sub>2</sub> mm	S mm		ORDER NO. Right-hand rotation
4	12	10	10	10	515.412.11A
4	14	12	10	10	515.414.11A
4	15	14	10	10	515.415.11A
5	15	14	10	10	515.515.11A
6	14	12	10	10	515.614.11A
6	15	14	10	10	515.615.11A

Spare parts: 990.014.00 Screw  
991.060.00 Hex key

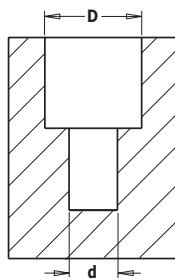

#### TECHNICAL DETAILS:

- Strength steel.
- Countersink: 2 carbide tipped cutting edges [Z2] at 90°.
- Fastening screw for quick and easy drill bit change.
- HSS drill bit.
- Stop collars with precision clamping nut for quick and easy assembly.
- The DELRIN® protection sleeve lets you work without marring the workpiece.

#### APPLICATION:

for drilling countersink and blind holes in solid wood, wood derivatives and laminates. For use with hand-held power drills or drill presses.

Spare parts

515.412.11	517.040.51P	541.101.00
515.414.11	517.040.51P	541.121.00
515.415.11	517.040.51P	541.141.00
515.515.11	517.050.51P	541.141.00
515.614.11	517.060.51P	541.121.00
515.615.11	517.060.51P	541.141.00



## Stop Collars with DELRIN® Sleeve

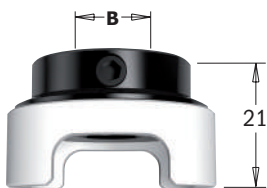

### 541

B mm		ORDER NO.
10	1	541.101.00
12	1	541.121.00
14	1	541.141.00

Spare parts

990.014.00	991.060.00
990.014.00	991.060.00
990.014.00	991.060.00

#### TECHNICAL DETAILS:

- Stop collars with precision clamping nut for quick and easy assembly.
- The DELRIN® protection sleeve lets you work without marring the workpiece.

## 45° Countersink with Parallel Shank

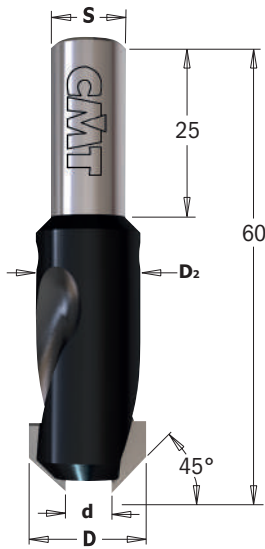

**521**

**HW** **Z2** **RH** **LH**

d mm	D mm	D <sub>2</sub> mm	A	S mm		ORDER NO. Right-hand rotation	ORDER NO. Left-hand rotation
3	12	10	45°	8	10	<b>521.312.11</b>	<b>521.312.12</b>
4	12	10	45°	8	10	<b>521.412.11</b>	<b>521.412.12</b>
4,5	16	14	45°	10	10	<b>521.4516.11</b>	
5	16	14	45°	10	10	<b>521.516.11</b>	<b>521.516.12</b>
6	16	14	45°	10	10	<b>521.616.11</b>	<b>521.616.12</b>

Spare parts

	990.014.00
	990.014.00
	990.014.00
	990.014.00
	990.014.00

Spare parts: **991.060.00** 2mm hex key

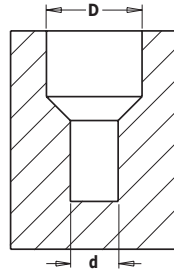

**TECHNICAL DETAILS:**

- Strength steel.
- Countersink: 2 carbide tipped cutting edges [Z2] at 45°.
- Fastening screw for quick and easy drill bit change.

**APPLICATION:**

for use with spiral bits featuring a parallel shank of equal dimension to countersink shank diameter.

## 90° Countersink with Parallel Shank

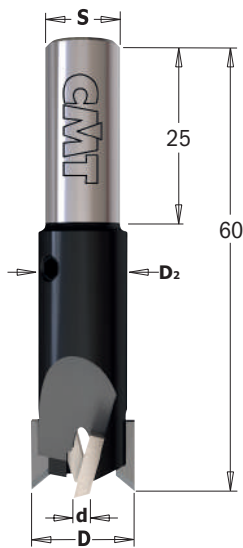

**515**

**HW** **Z2** **V2** **RH**

d mm	D mm	D <sub>2</sub> mm	A	S mm		ORDER NO. Right-hand rotation	
4	12	10	90°	10	10	<b>515.412.11</b>	
4	14	12	90°	10	10	<b>515.414.11</b>	
4	15	14	90°	10	10	<b>515.415.11</b>	
5	15	14	90°	10	10	<b>515.515.11</b>	
6	14	12	90°	10	10	<b>515.614.11</b>	
6	15	14	90°	10	10	<b>515.615.11</b>	

Spare parts

	990.014.00
	990.014.00
	990.014.00
	990.014.00
	990.014.00
	990.014.00

Spare parts: **991.060.00** 2mm hex key

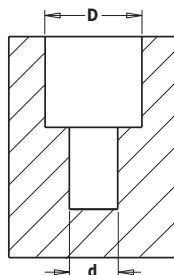

**TECHNICAL DETAILS:**

- Strength steel.
- Countersink: 2 carbide tipped cutting edges [Z2] at 90°.
- Fastening screw for quick and easy drill bit change.

**APPLICATION:**

for use with spiral bits featuring a parallel shank of equal dimension to countersink shank diameter.



# 90° Solid Carbide Countersink with Parallel Shank

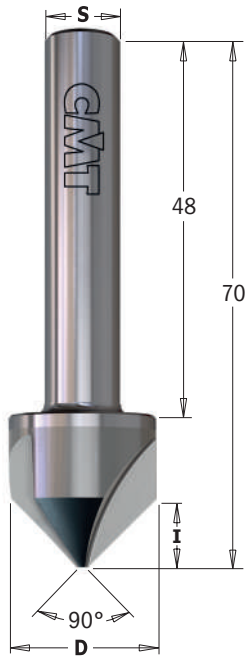

## 521

HWM Z3 RH

D mm	I mm	L mm	S mm		ORDER NO. Right-hand rotation
19,5	9	70	10x48	10	521.002.11

### TECHNICAL DETAILS:

- Premium quality strength steel body.
- High quality HW tip.
- 3 cutting edges [Z3] at 90°.
- Parallel shank.

### APPLICATION:

for making 90° countersinks for the insertion of screws that sit flush with the surface. Suitable for wood, wood-based, non-ferrous materials and metal.

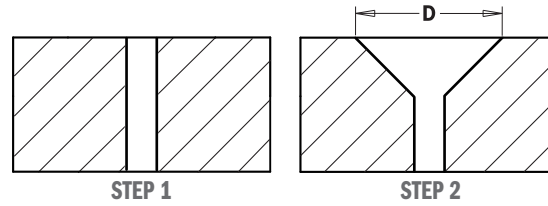

# Drill Bit with Countersink for Screw Joints

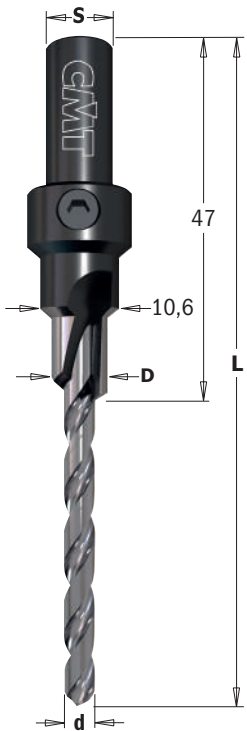

## 515

SP Z1 RH

d mm	D mm	L mm	S mm		ORDER NO. Right-hand rotation
4,2	7,6	87	9	1	515.042.31
5	7,6	93,7	9	1	515.050.31

### TECHNICAL DETAILS:

- SP steel.
- Countersink: 1 SP cutting edge [Z1].
- HSS drill bit.

### APPLICATION:

for drilling blind holes in soft and hardwood.

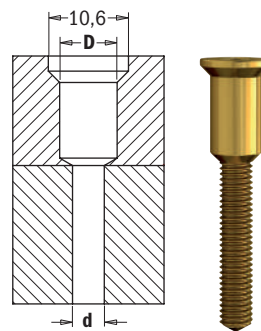

# CMT XTREME FAST AND PUSH&LOCK SYSTEMS: NEXT GENERATION HOLE SAW



These hole saws, equipped with the new **XTREME FAST** system, have been improved to ensure maximum productivity, lifetime and unbeatable performance in all materials. The innovative patented **PUSH&LOCK** system makes the traditional hole saw arbor obsolete.

**NEW FEATURES:** 1. One **PUSH&LOCK** arbor for all Hole Saw Series & Diameters. 2. Change your Hole Saw, with a simple **PUSH&LOCK**. 3. Release Plug with a push. 4. Enlarge the existing hole.

## SERIES 550X: MULTI-PURPOSE



**HW**  
**10X**  
LONGER LIFE  
**5X**  
FASTER

### MATERIALS



## SERIES 551X: BI-METAL PLUS



**BIM**  
8% Co  
**2X**  
LONGER LIFE

### MATERIALS

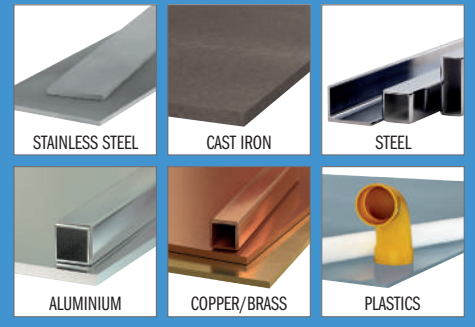

## SERIES 552: DIAMOND DRY



**GRIT**  
**LONG**  
LIFE

### MATERIALS



## CLAMSHELL PACKAGING

Hole Saws ≥Ø160mm are packaged in a carton box.

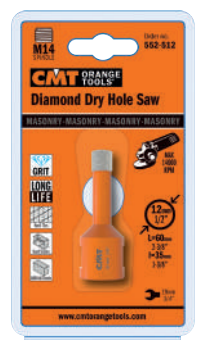

# HOLE SAWS & MULTI-MATERIAL WHEELS



PRODUCTS	PAGE
XTREME FAST Hole Saw Arbors, Pilot Drills & Kit	378-379
XTREME FAST Hole Saw Adaptors	379
XTREME FAST Multi-Purpose Hole Saws	380-381
XTREME FAST Bi-Metal Plus Hole Saw	382-383
Diamond Dry Hole Saws for Drill	384
Diamond Dry Hole Saws for Angle Grinder	385-387
Multi-Materials Carbide Wheel	388
Multi-Materials Diamond Dry Wheel	389
Toolcase for XTREME FAST Hole Saws	390





# CMT XTREME FAST AND PUSH&LOCK SYSTEMS: NEXT GENERATION HOLE SAW

XTREME  
FAST

PUSH  
& LOCK

## 1. One PUSH&LOCK arbor for all Hole Saw Series & Diameters

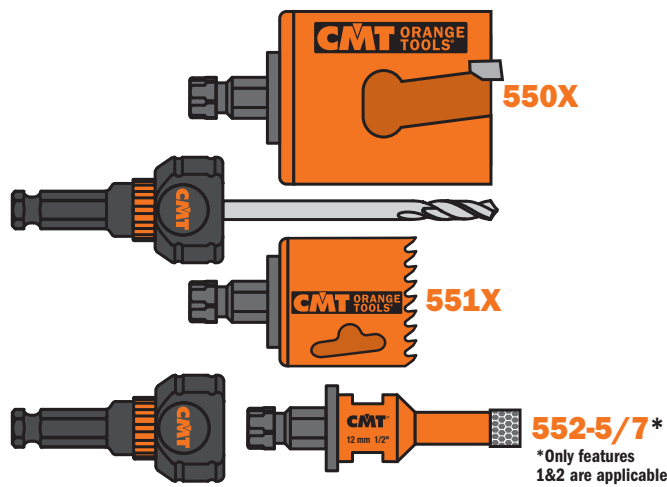

## 2. Change your Hole Saw with a simple PUSH&LOCK

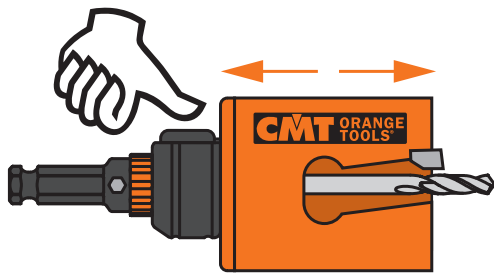

## 3. Release Plug with a push

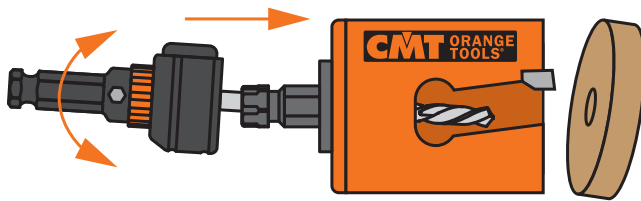

## 4. Enlarge the existing hole (Use adaptor set 550-PA05)



XTREME FAST & FASTX4 COMPATIBILITY (NEW & PREVIOUS SYSTEM)



# Do you already have a CMT Hole Saw with the previous FASTX4 System? **NO PROBLEM, IT'S STILL GOOD TO GO!**



1. Carefully and firmly secure your FAST4X Hole Saw. This will prevent damage to the tool and bodily injury while handling.
2. Unscrew the adaptor attached to your previous FASTX4 Hole Saw.



3. Replace the previous FASTX4 adaptor with the new XTREME FAST adaptor.

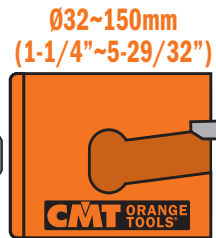
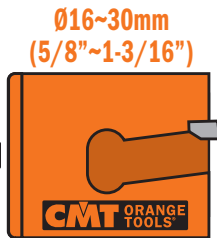

4. Carefully tighten the new adaptor to the Hole Saw with a 13mm spanner. 13mm

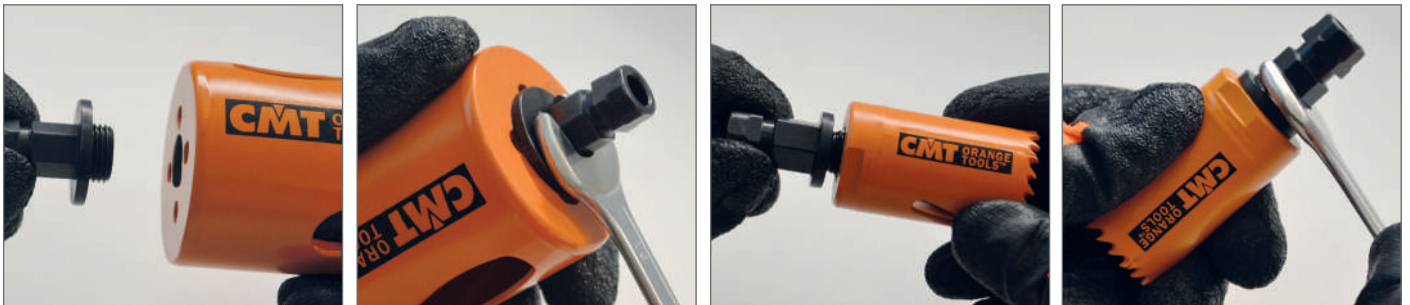

**5. Your Hole Saw is now compatible with the new **PUSH & LOCK** PUSH&LOCK System. YOU'RE GOOD TO GO!**



One **PUSH&LOCK** arbor for all Hole Saw Series & Diameters 

**550-PH85**

**PUSH&LOCK** arbor for **XTREME FAST** system, shank **HEX8.5mm** (11/32").  
Compatible with chucks  $\leq 25/64"$  (10mm).  
**HSS** pilot drill (**550-PD02** included)

Suitable for Series:

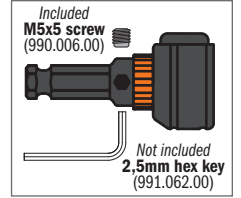

**550-PH11**

**PUSH&LOCK** arbor for **XTREME FAST** system, shank **HEX11mm** (7/16").  
Compatible with chucks  $\leq 1/2"$  (13mm). **HEAVY DUTY**.  
**HSS** pilot drill (**550-PD02** included)

Suitable for Series:

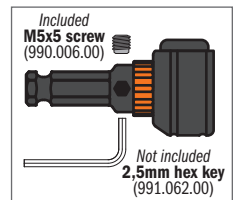

**550-PHSD**

**PUSH&LOCK** arbor for **XTREME FAST** system, shank **SDS PLUS**.  
Compatible with **SDS PLUS** power tools.  
**HSS** pilot drill (**550-PD02** included)

Suitable for Series:

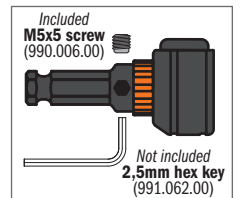

**550-PD01**

**HW** Pilot drill for **PUSH&LOCK** arbor,  $\varnothing 7\text{mm}$  (17/64"), L=125mm (4-15/16").

Suitable for Series:



**MATERIALS**

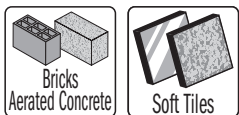

**550-PD02**

**HSS** Pilot drill for **PUSH&LOCK** arbor,  $\varnothing 6.35\text{mm}$  (1/4"), L=125mm (4-15/16").

Suitable for Series:



**MATERIALS**





**XTREME FAST** system is compatible with all Hole Saw Series & Diameters **XTREME FAST**

**550-PA01** (3pcs.)

XTREME FAST Adaptor 1/2"-20 for hole saw Ø16~30mm (5/8"~1-3/16")



Suitable for Series:



Ø16~30mm  
(5/8"~1-3/16")



**550-PA02** (3pcs.)

XTREME FAST Adaptor 5/8"-18 for hole saw Ø32~150mm (1-1/4"~5-29/32")



Suitable for Series:



Ø32~150mm  
(1-1/4"~5-29/32")



**550-PA03** (3pcs.)

XTREME FAST Adaptor 5/8"-18 for hole saw ≥Ø152mm (6")



Suitable for Series:



≥Ø152mm  
(6")



**550-PA04** (3pcs.)

XTREME FAST Adaptor M14 for hole saw series 552-5



Suitable for Series:



\*Pilot drill of PUSH&LOCK arbor must be disassembled during use with this series

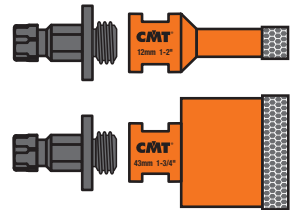

**550-PA05 KIT FOR ENLARGMENT EXISTING HOLE** (3pcs. LONG SPINDLE)

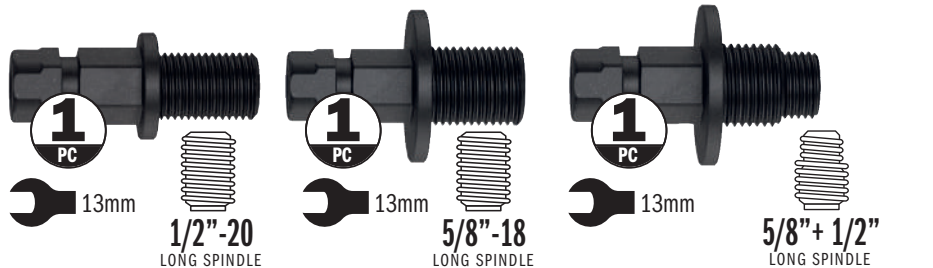

Suitable for Series:



Example of assembly for existing hole enlargement

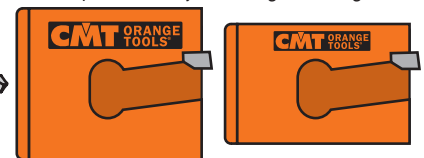

**550-PA06 STARTER KIT** (1pc. 550-PH85, 2pcs. 550-PA01, 3pcs. 550-PA02)



**1** PCS 550-PH85

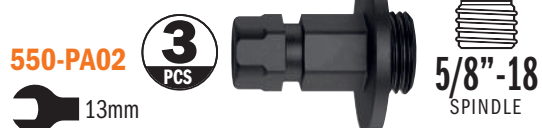
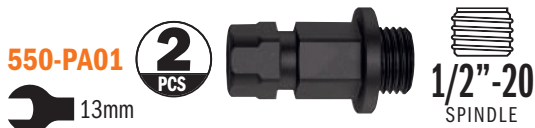

# Multi-Purpose Hole Saws

new

**CMT ORANGE TOOLS®**

**550X**

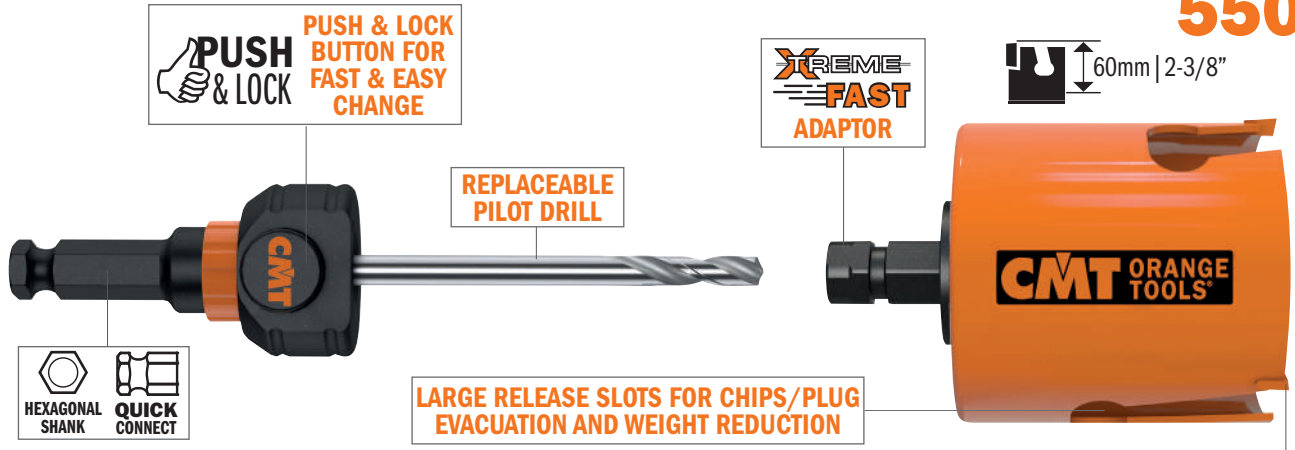

**SECURED TOOTH TECHNOLOGY**

Thanks to advanced technology, cutting teeth are securely anchored to body, which means they stand up better to hard materials and breakage.



**FASTER 5X** **10X LONGER LIFE**

**CONSTRUCTION CARBIDE**

Specially formulated construction carbide, used for cutting teeth provide 10X times longer cutting life and performs 5X faster than the standard hole saw.



**MATERIALS**

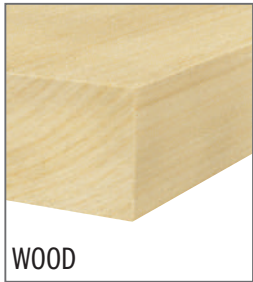

**SPEED KILLS!**

Operating at higher speeds than those indicated will shorten hole saw life and produce poor quality holes.

**PRE-BORE:**

For best results, always pre-bore with the pilot drill only.

**NEVER USE HAMMER MECHANISM WITH THESE HOLESAWS!**



**APPLICATIONS:** examples on wood, brick, plastic.



# Multi-Purpose Hole Saws

new

**CMT ORANGE TOOLS®**



ALL HOLE SAWS 550X ARE EQUIPPED WITH AN XTREME FAST ADAPTOR

**XTREME FAST**

mm	D inches	Z	WOOD/PLYWOOD RPM*	MDF/LAMINATES RPM*	PLASTERBOARD RPM*	PLASTICS RPM*	BRICK/AERATED CONCRETE RPM*	SOFT TILES RPM*		ORDER NO.
19	3/4	1	2300	2300	2300	2100	900	700	10	550-019X
20	25/32	1	2200	2200	2200	2000	900	600	10	550-020X
22	7/8	1	2000	2000	2000	1800	800	600	10	550-022X
25	1	1	1800	1800	1800	1600	700	500	10	550-025X
29	1-1/8	1	1500	1500	1500	1400	600	400	10	550-029X
30	1-3/16	1	1500	1500	1500	1300	600	400	10	550-030X
32	1-1/4	1	1400	1400	1400	1200	500	400	10	550-032X
35	1-3/8	1	1300	1300	1300	1100	500	300	10	550-035X
38	1-1/2	2	1100	1100	1100	1000	400	300	10	550-038X
40	1-9/16	2	1100	1100	1100	1000	400	300	10	550-040X
44	1-3/4	2	1000	1000	1000	900	400	300	10	550-044X
48	1-7/8	2	900	900	900	800	300	200	10	550-048X
51	2	3	800	800	800	800	300	200	10	550-051X
52	2-1/16	3	800	800	800	700	300	200	10	550-052X
54	2-1/8	3	800	800	800	700	300	200	10	550-054X
56	2-3/16	3	800	800	800	700	300	200	10	550-056X
57	2-1/4	3	700	700	700	700	300	200	10	550-057X
60	2-3/8	3	700	700	700	600	300	200	10	550-060X
64	2-1/2	3	700	700	700	600	200	200	10	550-064X
65	2-9/16	3	700	700	700	600	200	200	10	550-065X
68	2-11/16	3	600	600	600	600	200	100	10	550-068X
70	2-3/4	3	600	600	600	500	200	100	10	550-070X
73	2-7/8	3	600	600	600	500	200	100	10	550-073X
76	3	4	500	500	500	500	200	100	10	550-076X
79	3-1/8	4	500	500	500	500	200	100	10	550-079X
80	3-5/32	4	500	500	500	500	200	100	10	550-080X
82	3-15/64	4	500	500	500	500	200	100	10	550-082X
83	3-1/4	4	500	500	500	400	200	100	10	550-083X
89	3-1/2	4	500	500	500	400	200	100	10	550-089X
92	3-5/8	4	400	400	400	400	200	100	10	550-092X
102	4	5	400	400	400	400	100	100	5	550-102X
105	4-1/8	5	400	400	400	300	100	100	5	550-105X
108	4-1/4	5	400	400	400	300	100	100	5	550-108X
111	4-3/8	5	400	400	400	300	100	100	5	550-111X
114	4-1/2	5	300	300	300	300	100	100	5	550-114X
118	4-5/8	6	300	300	300	300	100	100	2	550-118X
127	5	6	300	300	300	300	100	100	2	550-127X
133	5-1/4	6	300	300	300	300	100	100	2	550-133X
152	6	6	200	200	200	200	100	50	2	550-152X
160	6-5/16	7	200	200	200	200	100	50	1	550-160X
168	6-5/8	7	200	200	200	200	100	50	1	550-168X
185	7-5/16	8	200	200	200	200	100	50	1	550-185X
210	8-1/4	8	200	200	200	100	50	50	1	550-210X

\*SUGGESTED RPM



**APPLICATIONS**  
electric flush-mount case installation.

Example of commercial electric flush-mount boxes

mm	D inches	Z	WOOD/PLYWOOD RPM*	MDF/LAMINATES RPM*	PLASTERBOARD RPM*	PLASTICS RPM*	BRICK/AERATED CONCRETE RPM*	SOFT TILES RPM*		ORDER NO.
68 - 73	2-11/16 - 2-7/8	3+3	600	600	600	600	200	100	10	550-068CSX



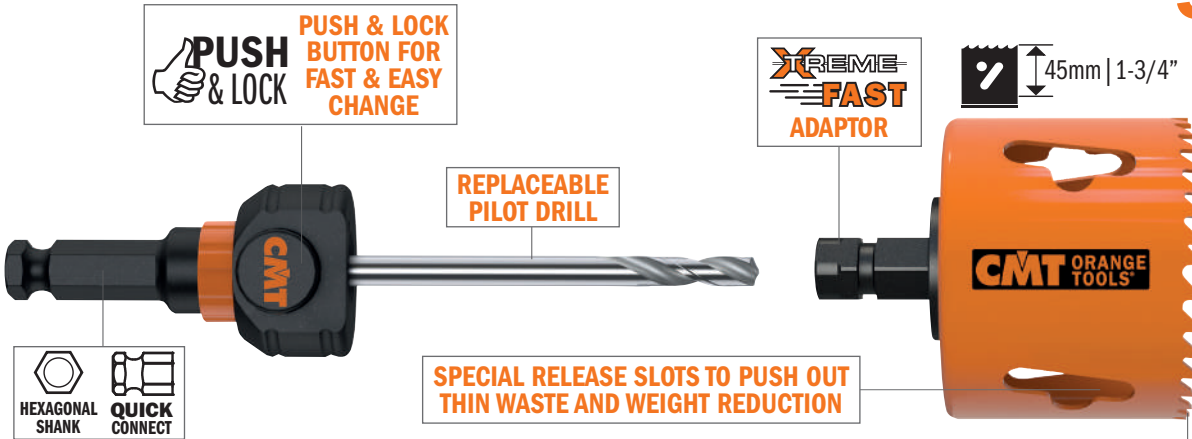

**TOOTH DESIGN**

Special tooth geometry with variable pitch (4~6 TPI) provides a smoother cut and better chip clearance preventing clogging and heat build-up. Teeth are alternate & side set to minimize binding and friction therefore requiring less feed pressure.

**ALTERNATE & SIDE SET TEETH VARIABLE PITCH (4~6 TPI)**



**BI-METAL 8% COBALT**

Teeth made with Bi-metal 8% Cobalt provide extreme results. Superior performance and 2X longer cutting life than the standard hole saw.

**BIM 8% Co 2X LONGER LIFE**

**MATERIALS**



**COOLING LUBRICANT:**

When drilling metals, lubrication serves several purposes:

- it cools the saw and workpiece
- it reduces heat and abrasion which shortens cutting life
- it helps remove swarf from the cutting surface
- it extends hole saw life by 500%.



**SPEED KILLS!**

Operating at higher speeds than those indicated will shorten hole saw life and produce poor quality holes.

**FEED PRESSURE:**

Always consider materials in use and project type. Apply sufficient feed pressure to aid proper chip removal. Reduce the pressure when hole saw becomes hot or if teeth start to clog. Insufficient feed pressure will lead to premature tooth dulling. Too much pressure will damage teeth.

**PRE-BORE:**

For best results, always pre-bore with the pilot drill only.

**NEVER USE HAMMER MECHANISM WITH THESE HOLESAWS!**



**APPLICATIONS:** examples on steel, sandwich material.



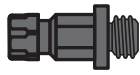

ALL HOLE SAWS 551X ARE EQUIPPED WITH AN XTREME FAST ADAPTOR



D		STAINLESS STEEL	CAST IRON	STEEL	ALUMINIUM	COPPER/BRASS	PLASTICS		ORDER NO.
mm	inches	RPM*	RPM*	RPM*	RPM*	RPM*	RPM*		
16	5/8	160	240	320	500	500	500	10	551-016X
19	3/4	140	200	280	420	420	420	10	551-019X
20	25/32	120	200	260	400	400	400	10	551-020X
22	7/8	120	180	240	360	360	360	10	551-022X
25	1	100	160	200	320	320	320	10	551-025X
27	1-1/16	80	140	180	300	300	300	10	551-027X
29	1-1/8	80	140	180	280	280	280	10	551-029X
30	1-3/16	80	120	160	260	260	260	10	551-030X
32	1-1/4	80	120	160	240	240	240	10	551-032X
35	1-3/8	60	100	140	220	220	220	10	551-035X
38	1-1/2	60	100	140	200	200	200	10	551-038X
40	1-9/16	60	100	120	200	200	200	10	551-040X
43	1-11/16	60	80	120	180	180	180	10	551-043X
44	1-3/4	60	80	120	180	180	180	10	551-044X
48	1-7/8	40	80	100	160	160	160	10	551-048X
51	2	40	80	100	160	160	160	10	551-051X
52	2-1/16	40	60	100	140	140	140	10	551-052X
54	2-1/8	40	60	80	140	140	140	10	551-054X
57	2-1/4	40	60	80	140	140	140	10	551-057X
60	2-3/8	40	60	80	120	120	120	10	551-060X
64	2-1/2	40	60	80	120	120	120	10	551-064X
65	2-9/16	40	60	80	120	120	120	10	551-065X
68	2-11/16	20	60	60	120	120	120	10	551-068X
70	2-3/4	20	40	60	100	100	100	10	551-070X
73	2-7/8	20	40	60	100	100	100	10	551-073X
76	3	20	40	60	100	100	100	10	551-076X
79	3-1/8	20	40	60	100	100	100	10	551-079X
83	3-1/4	20	40	60	80	80	80	10	551-083X
86	3-3/8	20	40	60	80	80	80	10	551-086X
89	3-1/2	20	40	60	80	80	80	10	551-089X
92	3-5/8	20	40	40	80	80	80	10	551-092X
102	4	20	40	40	80	80	80	5	551-102X
105	4-1/8	20	20	40	60	60	60	5	551-105X
108	4-1/4	20	20	40	60	60	60	5	551-108X
114	4-1/2	20	20	40	60	60	60	5	551-114X
127	5	20	20	40	60	60	60	2	551-127X
133	5-1/4	20	20	40	60	60	60	2	551-133X
140	5-1/2	10	20	20	40	40	40	2	551-140X
152	6	10	20	20	40	40	40	2	551-152X
168	6-5/8	10	20	20	40	40	40	1	551-168X

\*SUGGESTED RPM

# Diamond Dry Hole Saws

Diamond dry hole saws with continuous edge have been specially developed for professionals that need to drill in extremely tough materials like **HARD TILES (ceramic, gres, etc.)**, **HARD STONES (granite, marble, etc.)**, **ARTIFICIAL STONES (OKITE®, SILESTONE®, etc.)**, in which it is increasingly difficult to drill with conventional hole saws. Drilling other masonry materials is also possible, but it will reduce tool life. These hole saws guarantee excellent performance and superior lifetime!

**552**

## MATERIALS



**DIAMOND GRIT**  
Diamond grit featuring strong cubo-octahedral inclusion-free heat-resistant crystals, guarantees fast clean cutting and longer cutting life than the standard hole saw.



AVAILABLE WITH SHANK

HEXAGONAL SHANK

M14 SPINDLE

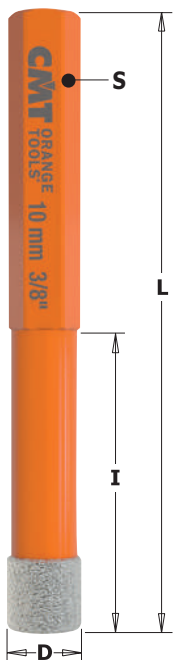

RPM 2200 ~ 4000\*

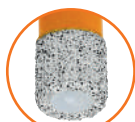

Filled with cooling wax **552-WAX**

## 552-0 FOR DRILL

mm	D inches	I mm	L mm	HARD TILES (CERAMIC & GRES) HARD STONES, ARTIFICIAL STONES	S		ORDER NO.
5	13/64	30	68	RPM 2200 ~ 4000 *	Hexagonal	10	552-005
6	1/4	30	68	RPM 2200 ~ 4000 *	Hexagonal	10	552-006
8	5/16	40	80	RPM 2200 ~ 4000 *	Hexagonal	10	552-008
10	3/8	40	80	RPM 2200 ~ 4000 *	Hexagonal	10	552-010
12	15/32	40	80	RPM 2200 ~ 4000 *	Hexagonal	10	552-012
14	9/16	40	80	RPM 2200 ~ 4000 *	Hexagonal	10	552-014
16	5/8	40	80	RPM 2200 ~ 4000 *	Hexagonal	10	552-016

\*We recommend the use of a high speed drill (minimum 14V)



## 552-WAX COOLING & LUBRICATING WAX

While drilling, the wax will melt away (eliminated along with drilling waste). This facilitates cooling and lubrication. Replenish wax after every use (when still warm) to extend lifetime.  
**Jar 30ml. (1 fl.Oz)**



PACK QTY. 10 pcs.



## 552-001-05

5 PIECE HOLE SAW SET

- 552-005 Ø5mm
- 552-006 Ø6mm
- 552-008 Ø8mm
- 552-010 Ø10mm
- 552-012 Ø12mm

PACK QTY. 10 pcs.

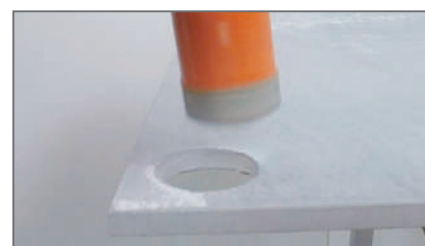
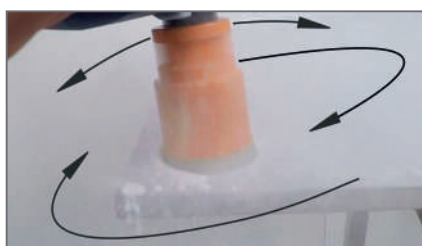
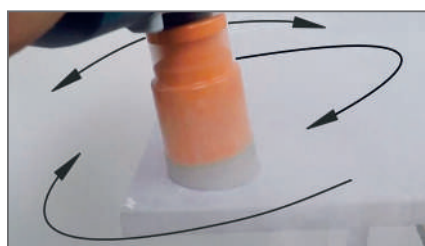
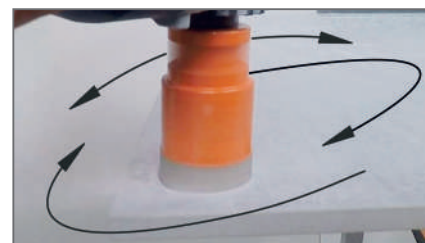
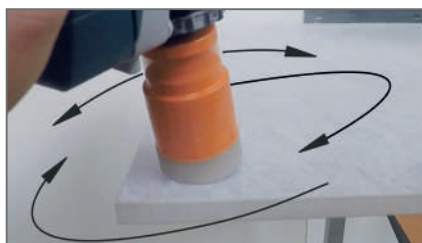
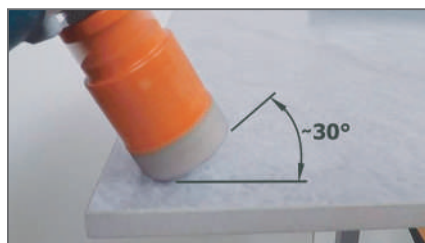



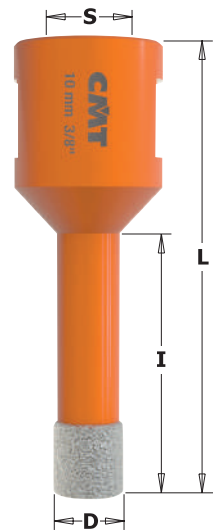

**M14**  
SPINDLE

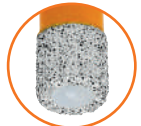

Filled with cooling wax **552-WAX** (until Ø16mm)



≥ Ø18mm without cooling wax

## 552-5 FOR ANGLE GRINDER

mm	D inches	I mm	L mm	HARD TILES (CERAMIC & GRES) HARD STONES, ARTIFICIAL STONES	S		ORDER NO.
5	13/64	35	60	MAX RPM 14000	M14	10	552-505
6	1/4	35	60	MAX RPM 14000	M14	10	552-506
8	5/16	35	60	MAX RPM 14000	M14	10	552-508
10	3/8	35	60	MAX RPM 14000	M14	10	552-510
12	1/2	35	60	MAX RPM 14000	M14	10	552-512
14	9/16	35	60	MAX RPM 14000	M14	10	552-514
16	5/8	35	60	MAX RPM 14000	M14	5	552-516
18	45/64	35	60	MAX RPM 14000	M14	5	552-518
20	13/16	35	60	MAX RPM 14000	M14	5	552-520
25	1	40	60	MAX RPM 14000	M14	5	552-525
28	1-1/8	40	60	MAX RPM 14000	M14	5	552-528
35	1-3/8	40	60	MAX RPM 14000	M14	5	552-535
43	1-3/4	40	60	MAX RPM 14000	M14	5	552-543
51	2	40	60	MAX RPM 14000	M14	5	552-551
55	2-3/16	40	60	MAX RPM 14000	M14	5	552-555
68	2-11/16	40	60	MAX RPM 14000	M14	5	552-568

Watch the video on



## 552-GUIDE

Drill Guide with Suction Cups - 7 holes  
Ø4 - 5 - 6 - 7 - 8 - 10 - 12mm  
Ø5/32" - 3/16" - 1/4" - 9/32" - 5/16" - 3/8" - 1/2"

PACK QTY. 10 pcs.



## 550-PA04

**XTREME FAST** Adaptor M14 (series 552-5) for **PUSH&LOCK** System (see page 5)



## 552-EX14

Hexagonal adaptor M14 (series 552-5) for drills



## 552-501-06

6 PIECE HOLE SAW SET

- 552-506 Ø6mm
- 552-508 Ø8mm
- 552-510 Ø10mm
- 552-512 Ø12mm
- 552-GUIDE
- 552-EX14

PACK QTY. 10 pcs.

## 552 RECOMMENDATIONS FOR USE:

Turn on drill to start tool rotation. Begin drilling at a 30° angle - this is the angle measured between the hole saw and the working surface. Cutting at an angle will prevent tool from slipping and facilitate precision centering. To improve stability during operation, use the working surface as leverage by resting the drill against it.

Continue the cut vertically, accompanying the tool in an orbital motion. This will favor better cooling and chip evacuation. (If you are using a guide, begin the cut vertically, then lift the guide and continue cutting in an orbital motion).

Remember, the hole saw is not a drill bit. Attempting to bore holes perpendicular to the work surface on a frequent basis will drastically reduce tool lifespan.

Using water as a cooling agent may help extend the life of the hole saw.

**RPM SUGGESTED?** High RPM values reduce the possibility of damaging/burning the diamond edge, ensuring a longer life.

**NEVER USE HAMMER MECHANISM WITH THESE HOLESAWS!**

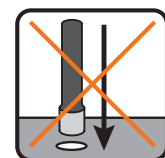

## Diamond Dry Special Bits

new

**CMT ORANGE TOOLS®**

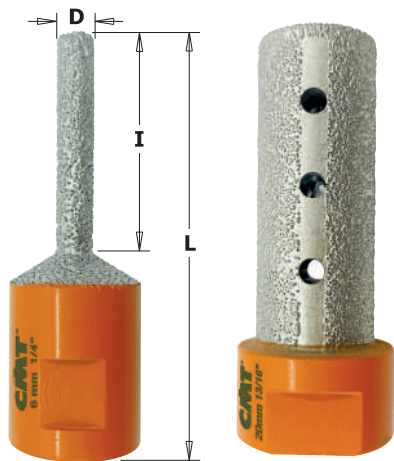

**M14**  
SPINDLE



**552-506M**

**552-520M**

## 552-M FOR ANGLE GRINDER

mm	D inches	I mm	L mm	S		ORDER NO.
6	1/4	35	65	M14	5	552-506M
20	13/16	50	65	M14	5	552-520M

**APPLICATIONS:**  
for Milling, Enlarging, Shaping,  
Countersinking on Existing Holes.

**TIPS:**  
it can also be used to create lateral semicircular recesses  
(for cables, pipes, etc.)



### MATERIALS



### 550-PA04

**XTREME FAST** Adaptor M14  
(series 552-5) for  
**PUSH&LOCK** System (see page 5)



### 552-EX14

Hexagonal adaptor M14  
(series 552-5) for drills



## Diamond Dry Special Bits

new

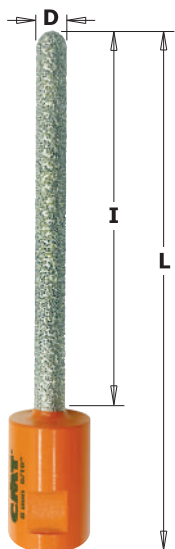

**M14**  
SPINDLE



## 552-508M FOR ANGLE GRINDER

mm	D inches	I mm	L mm	S		ORDER NO.
8	5/16	100	130	M14	5	552-508M

**APPLICATIONS:**  
for Raking out Mortar Joint and for Milling,  
Enlarging and Shaping Existing Holes.

**TIPS:**  
suitable for raking out mortar joints and removing bricks.



### MATERIALS



### 550-PA04

**XTREME FAST** Adaptor M14  
(series 552-5) for  
**PUSH&LOCK** System (see page 5)



### 552-EX14

Hexagonal adaptor M14  
(series 552-5) for drills



# Diamond Dry Special Bits

new

**CMT ORANGE TOOLS**

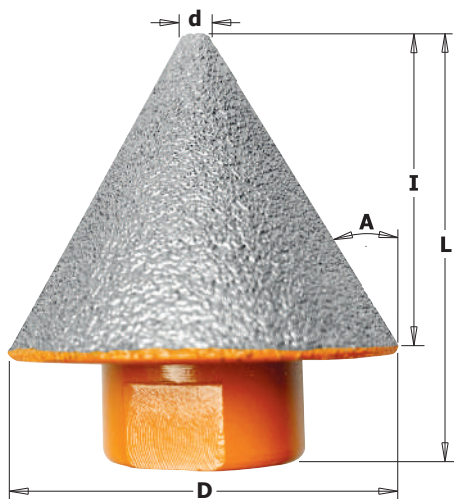

**M14**  
SPINDLE



## 552-CS FOR ANGLE GRINDER

mm	d inches	mm	D inches	I mm	A	S	ORDER NO.
5	13/64	35	1-3/8	30	65°	M14	552-535CS
30	1-3/16	70	2-3/4	50	45°	M14	552-570CS

**APPLICATIONS:**  
for Countersinking on Existing Holes.



### MATERIALS

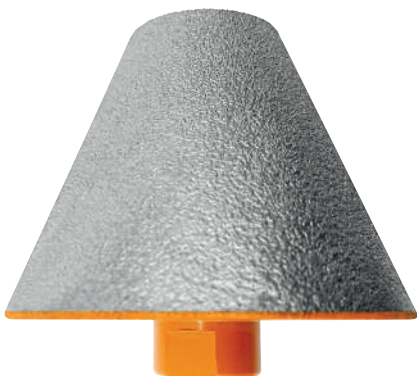

### 550-PA04

**XTREME FAST** Adaptor M14 (series 552-5) for **PUSH&LOCK** System (see page 5)



### 552-EX14

Hexagonal adaptor M14 (series 552-5) for drills



# Diamond Dry Wheels

new

## 552-115 FOR ANGLE GRINDER **CURVED**

mm	D inches	mm	B inches	GRIT	ORDER NO.
115	4-1/2	22,2	7/8	medium-fine	552-115-01
115	4-1/2	22,2	7/8	coarse	552-115-02

**APPLICATIONS:**  
for Smoothing, Trimming, Chamfering.



### MATERIALS



## 552-115 FOR ANGLE GRINDER **FLAT**

mm	D inches	S	GRIT	ORDER NO.
115	4-1/2	M14	medium-fine	552-115-03
115	4-1/2	M14	coarse	552-115-04

**APPLICATIONS:**  
for Smoothing, Trimming, Chamfering.

**M14**  
SPINDLE







**MULTI-MATERIALS**

## 286 ITK<sup>PLUS</sup>

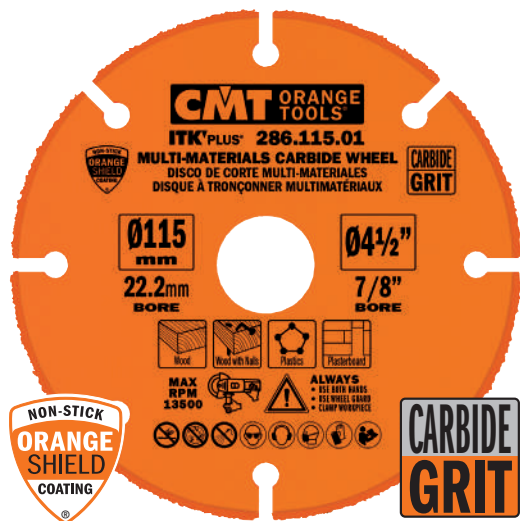

D mm	B mm		ORDER NO.
115	22,2 (+9,5+15,87)	10	286.115.01
125	22,2 (+20+15,87)	10	286.125.01
230	22,2	5	286.230.01

### MACHINES



ANGLE GRINDER



MINI CORDLESS CIRC. SAW

Blade diameter compatibility is contingent on machine type.

### MATERIALS



WOOD



WOOD/WOOD & NAILS

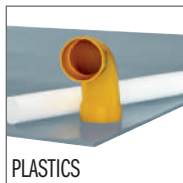

PLASTICS



PLASTERBOARD



**APPLICATIONS:** examples on wood, wood & nails and plastics.





**MULTI-MATERIALS**

**286.61 ITK<sup>+</sup>PLUS<sup>®</sup>**



D mm	B mm		ORDER NO.
115	22,2 (+9,5+15,87)	10	286.115.61
125	22,2 (+20+15,87)	10	286.125.61

## MACHINES



Blade diameter compatibility is contingent on machine type.

## MATERIALS

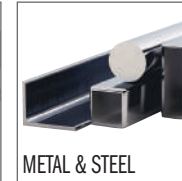
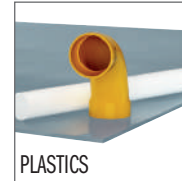

**APPLICATIONS:** examples on bricks, hard stone and artificial stone.





**XTREME  
FAST**

**PUSH  
& LOCK**



The toolcase is provided empty, image is purely indicative.  
A toolcase can contain 1 PUSH&LOCK arbor, 1 Pilot Drill and relative number of XTREME FAST Hole Saws.  
The number of Hole Saws to be contained is dependent on diameter.



UP TO  
**11**  
HOLE SAWS

UP TO  
**24**  
HOLE SAWS

UP TO  
**63**  
HOLE SAWS

DESCRIPTION	ORDER NO.
Toolcase <b>SMALL</b> - Up to <b>11</b> Hole Saws	<b>03.01.0531</b>
Toolcase <b>MEDIUM</b> - Up to <b>24</b> Hole Saws	<b>03.01.0532</b>
Toolcase <b>LARGE</b> - Up to <b>63</b> Hole Saws	<b>03.01.0533</b>

**FOR  
FREE!**

Toolcase **SMALL** (empty) is yours free when you purchase any **10PCS** of the **XTREME FAST** series.  
Toolcase **MEDIUM** (empty) is yours free when you purchase any **20PCS** of the **XTREME FAST** series.  
Toolcase **LARGE** (empty) is yours free when you purchase any **40PCS** of the **XTREME FAST** series.



[www.cmtorangetools.com](http://www.cmtorangetools.com)



**C.M.T. UTENSILI S.p.A.**

Via della Meccanica, sn  
61122 Pesaro (PU) - Italia

Tel. +39 0721 48571

Fax +39 0721 481021

[info@cmtorangetools.com](mailto:info@cmtorangetools.com)



Download this Catalogue



03.60.3006

15K0124